

---

# Computer graphics III – Light reflection, BRDF

---

Jaroslav Křivánek, MFF UK

[Jaroslav.Krivanek@mff.cuni.cz](mailto:Jaroslav.Krivanek@mff.cuni.cz)

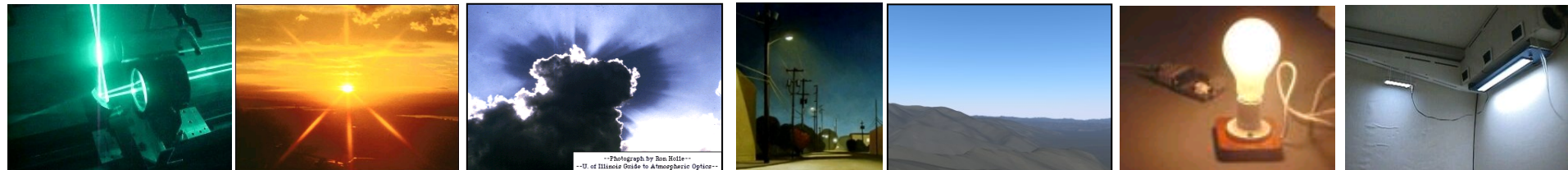

# Basic radiometric quantities

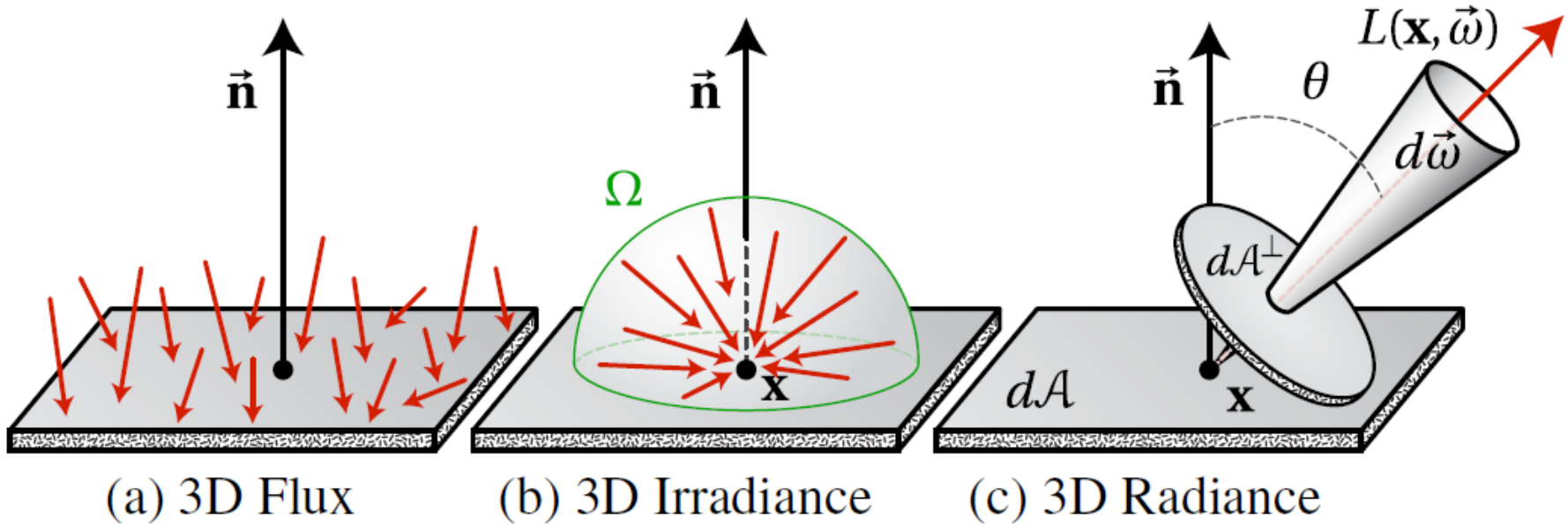

Image: Wojciech Jarosz

# Interaction of light with a surface

- Absorption
- Reflection
- Transmission / refraction
  
- Reflective properties of materials determine
  - the relation of **reflected** radiance  $L_r$  to **incoming** radiance  $L_i$ , and therefore
  
  - the **appearance** of the object: color, glossiness, etc.

# Interaction of light with a surface

- Same illumination
- Different materials

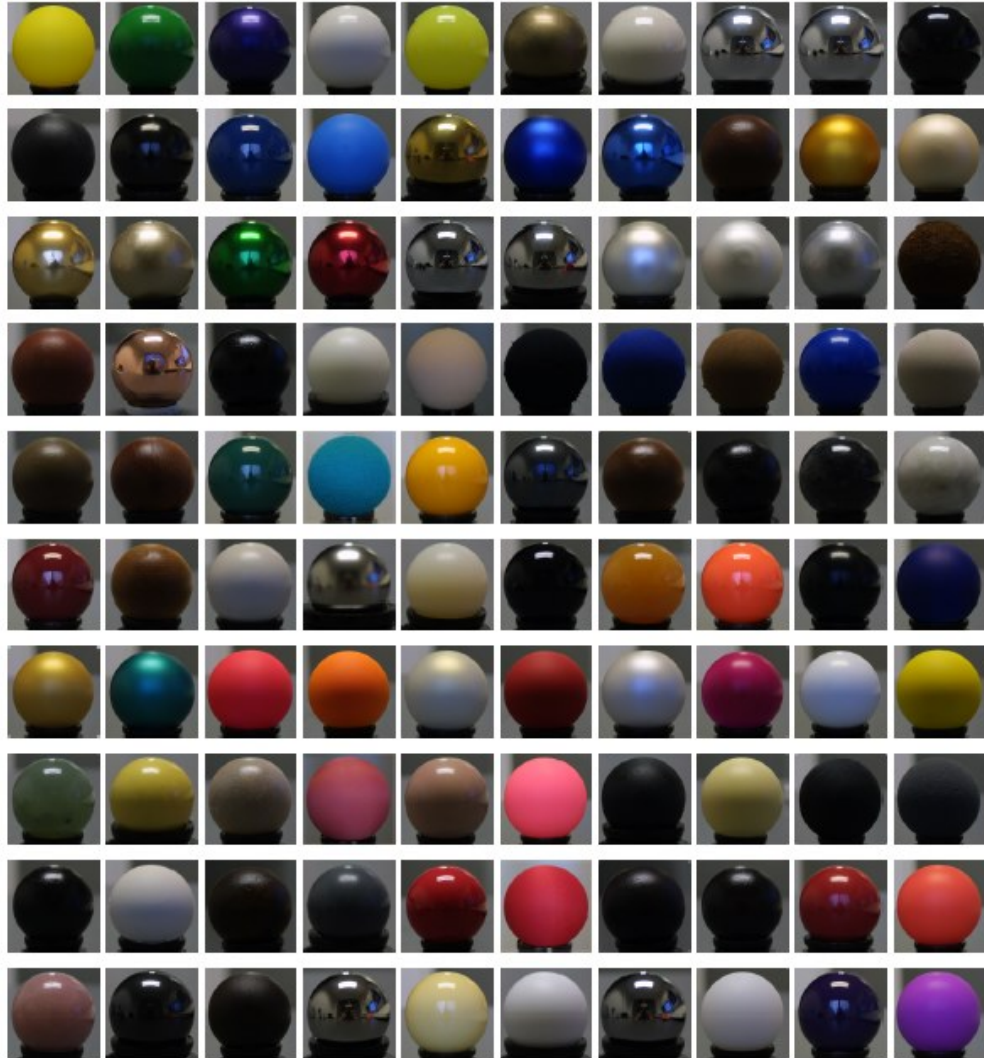

# BRDF – Formal definition

- **Bidirectional Reflectance Distribution Function**

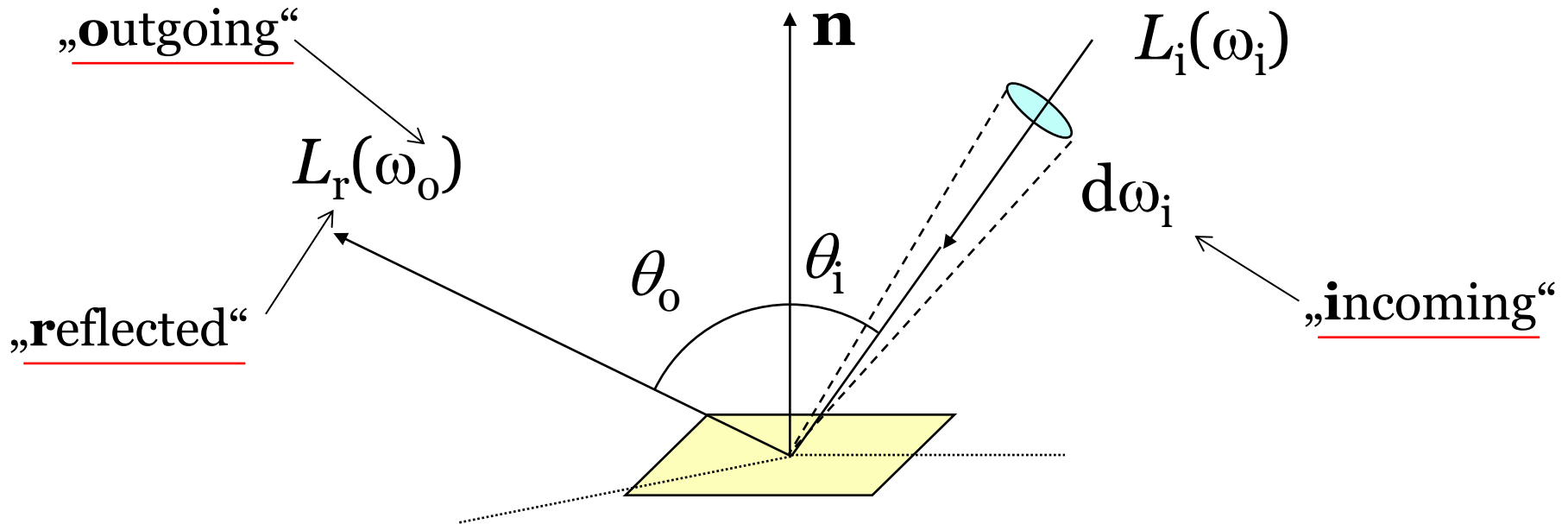

$$f_r(\omega_i \rightarrow \omega_o) = \frac{dL_r(\omega_o)}{L_i(\omega_i) \cdot \cos \theta_i \cdot d\omega_i} \quad [\text{sr}^{-1}]$$

# BRDF

- Mathematical model of the reflection properties of a surface
- Intuition
  - **Value of a BRDF = probability density**, describing the event that a light energy “packet”, or “photon”, coming from direction  $\omega_i$  gets reflected to the direction  $\omega_o$ .

- Range:

$$f_r(\omega_i \rightarrow \omega_o) \in [0, \infty)$$

# BRDF

- The BRDF is a **model of the bulk behavior of light** on the microstructure when viewed from distance

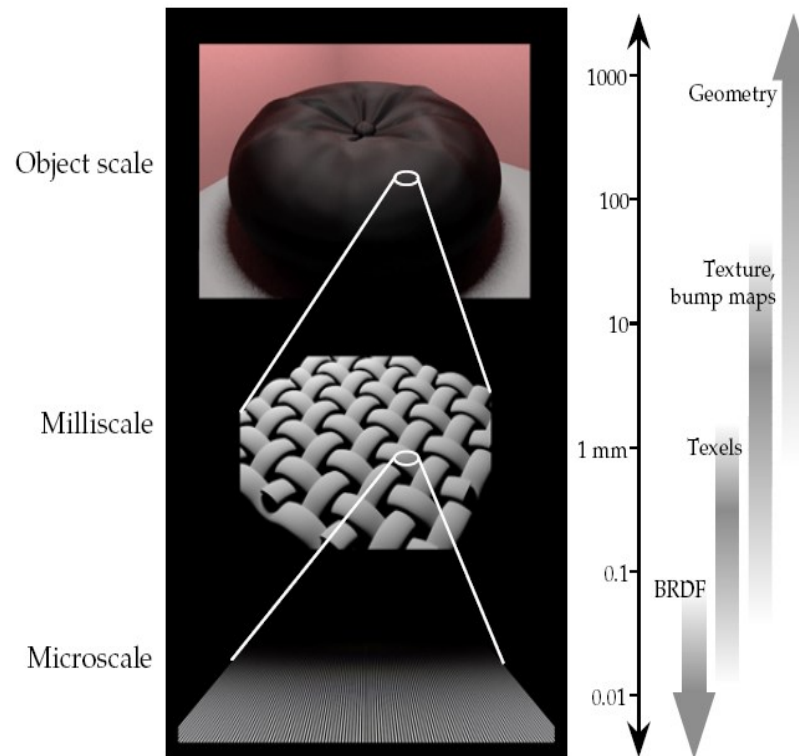

# BRDF properties

- **Helmholtz reciprocity** (always holds in nature, a physically-plausible BRDF model must follow it)

$$f_r(\omega_1 \rightarrow \omega_0) = f_r(\omega_0 \rightarrow \omega_1)$$

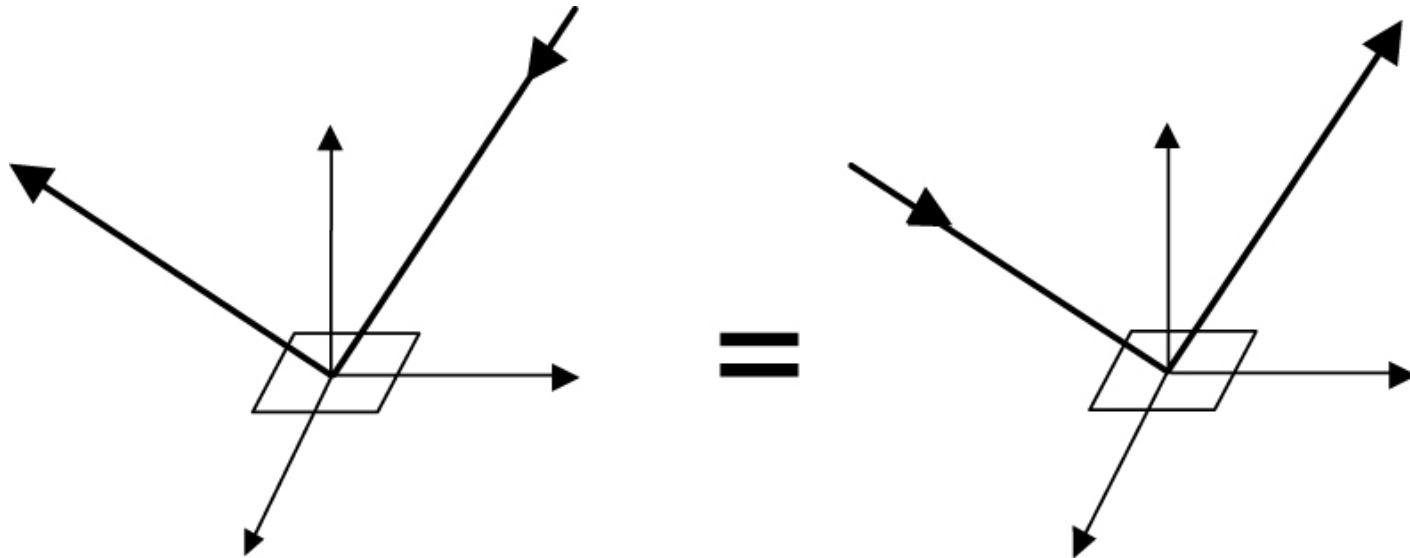



# BRDF properties

- **Energy conservation**

- A patch of surface cannot reflect more light energy than it receives

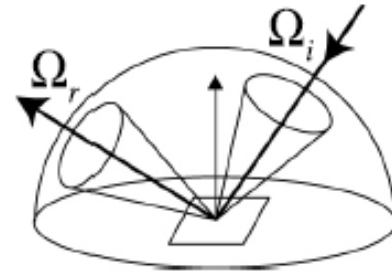

# BRDF (an)isotropy

- **Isotropic BRDF** = invariant to a rotation around surface normal

$$\begin{aligned} f_r(\theta_i, \phi_i; \theta_o, \phi_o) &= f_r(\theta_i, \phi_i + \phi; \theta_o, \phi_o + \phi) \\ &= f_r(\theta_i, \theta_o, \phi_o - \phi_i) \end{aligned}$$

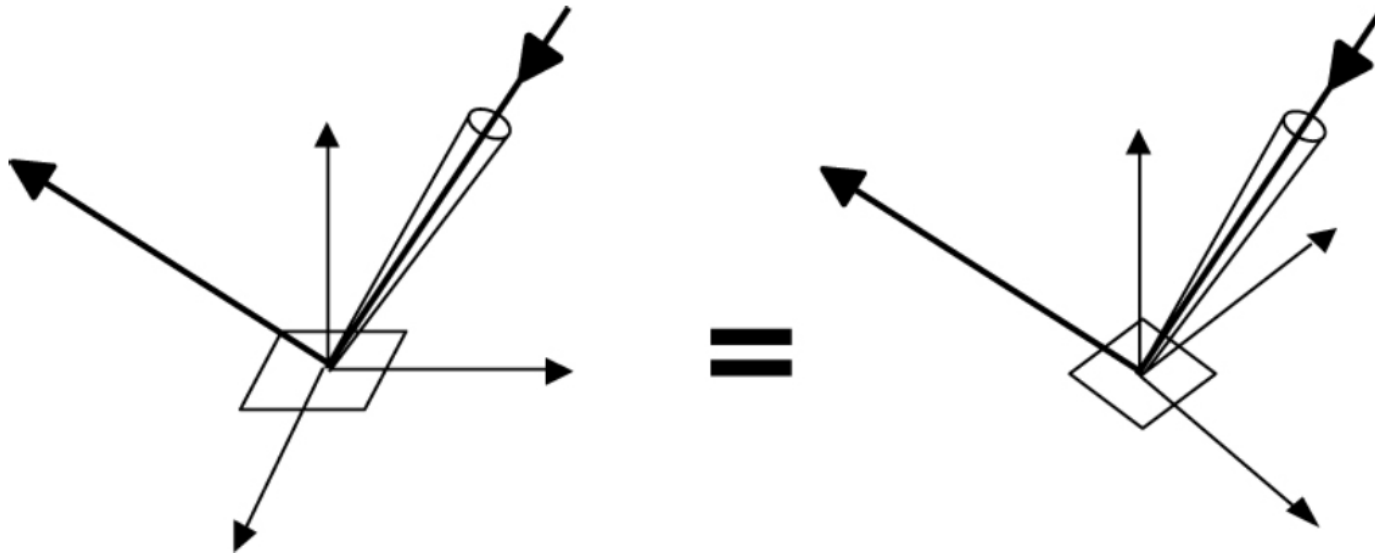

# Surfaces with anisotropic BRDF



Figure 9: Anisotropic Aluminum Wheel

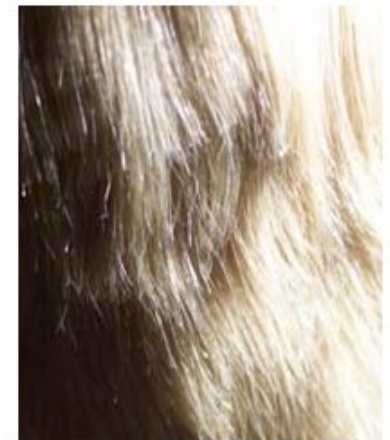
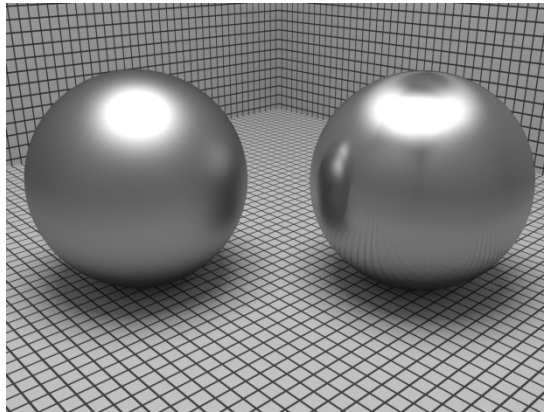
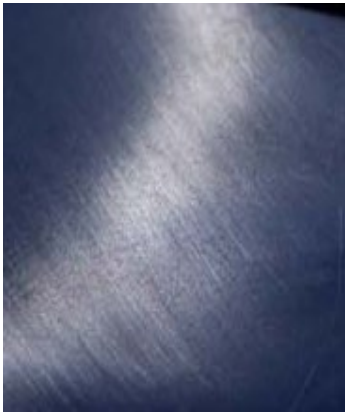
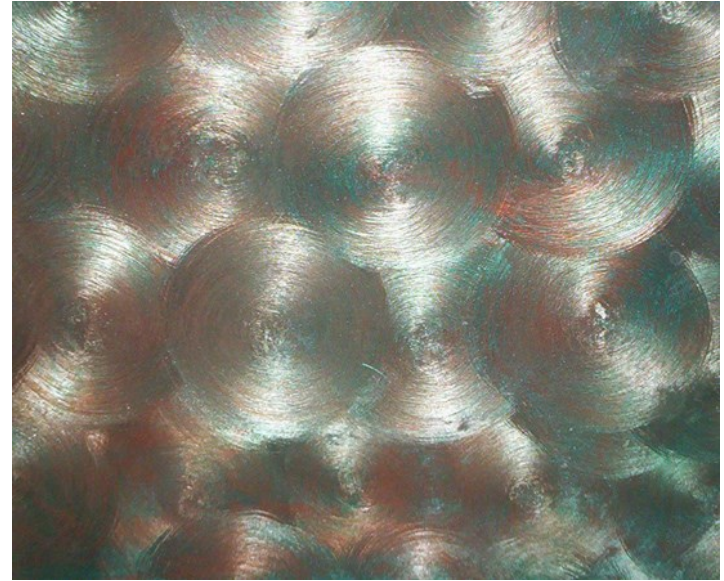

fibers

# Anisotropic BRDF

- Different microscopic roughness in different directions (brushed metals, fabrics, ...)

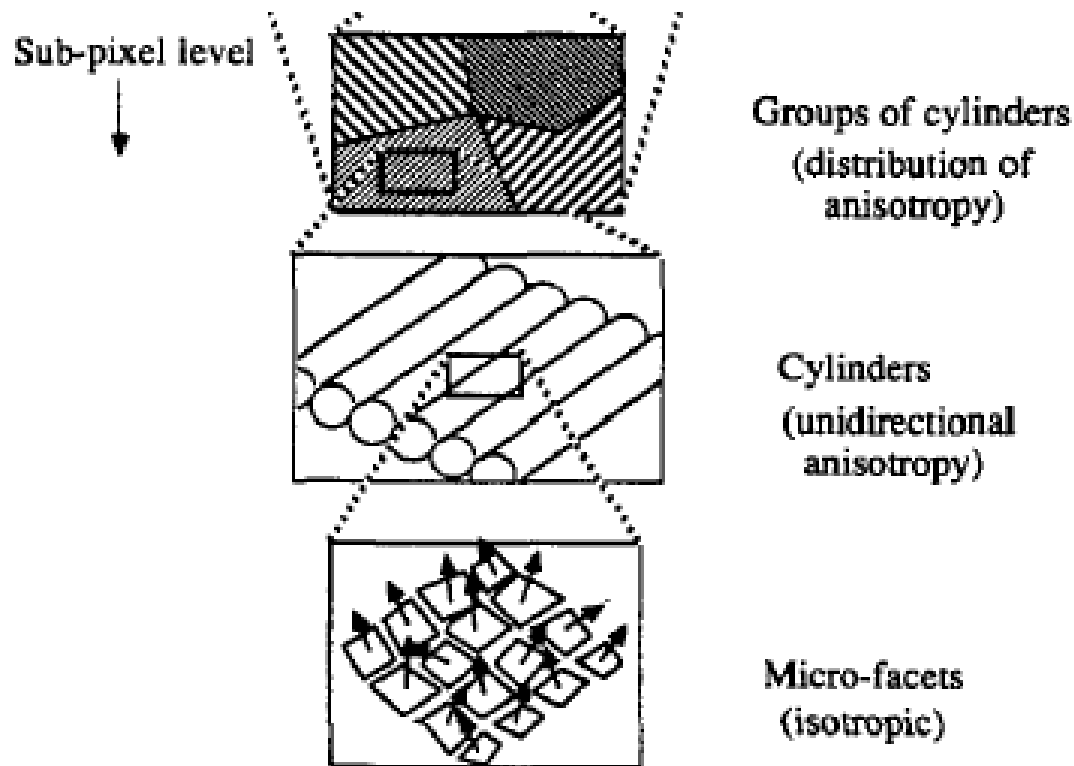

# Isotropic vs. anisotropic BRDF

- **Isotropic** BRDFs have only 3 degrees of freedom
  - Instead of  $\phi_i$  and  $\phi_o$  it is enough to consider only  $\Delta\phi = \phi_i - \phi_o$
  - But this is not enough to describe an anisotropic BRDF
- Description of an **anisotropic** BRDF
  - $\phi_i$  and  $\phi_o$  are expressed in a **local coordinate frame**  $(U, V, N)$ 
    - $U$  ... tangent – e.g. the direction of brushing
    - $V$  ... binormal
    - $N$  ... surface normal ... the  $Z$  axis of the local coordinate frame

# Reflection equation

- A.k.a. reflectance equation, illumination integral, OVTIGRE (“outgoing, vacuum, time-invariant, gray radiance equation”)
- “How much **total** light gets reflected in the direction  $\omega_o$ ?”
- From the definition of the BRDF, we have

$$dL_r(\omega_o) = f_r(\omega_i \rightarrow \omega_o) \cdot L_i(\omega_i) \cdot \cos \theta_i d\omega_i$$

# Reflection equation

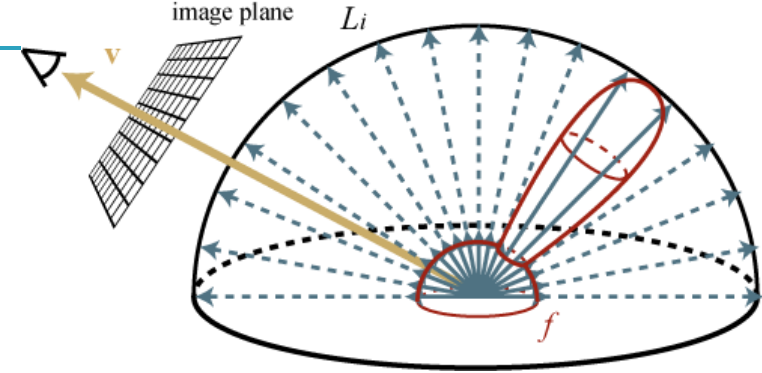

- Total reflected radiance: integrate contributions of incident radiance, weighted by the BRDF, over the hemisphere

$$L_r(\omega_o) = \int_{\text{upper hemisphere over } x} L_i(\omega_i) \cdot f_r(\omega_i \rightarrow \omega_o) \cdot \cos \theta_i \, d\omega_i$$

upper hemisphere over  $x$

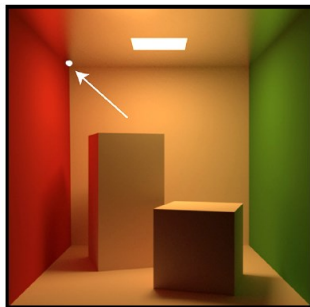

=  $\int$

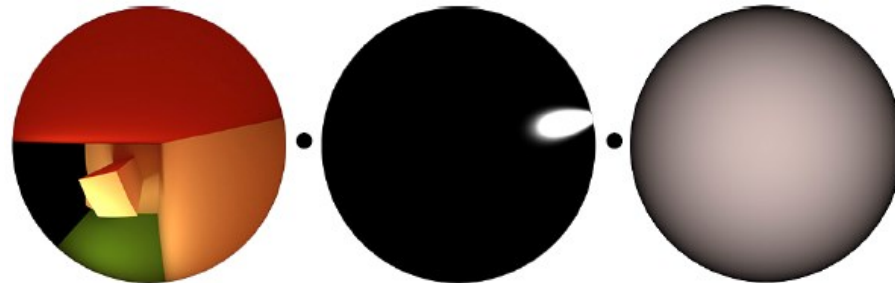

# Reflection equation

- Evaluating the reflectance equation renders images!!!
  - Direct illumination
    - Environment maps
    - Area light sources
    - etc.



# Energy conservation – More rigorous

- Reflected flux per unit area (i.e. radiosity  $B$ ) cannot be larger than the incoming flux per unit surface area (i.e. irradiance  $E$ ).

$$\begin{aligned}\frac{B}{E} &= \frac{\int L_r(\omega_o) \cos \theta_o d\omega_o}{\int L_i(\omega_i) \cos \theta_i d\omega_i} = \\ &= \frac{\int \left[ \int f_r(\omega_i \rightarrow \omega_o) L_i(\omega_i) \cos \theta_i d\omega_i \right] \cos \theta_o d\omega_o}{\int L_i(\omega_i) \cos \theta_i d\omega_i} = \\ &\leq 1\end{aligned}$$

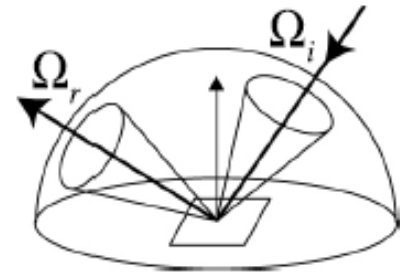

# Surface appearance and the BRDF

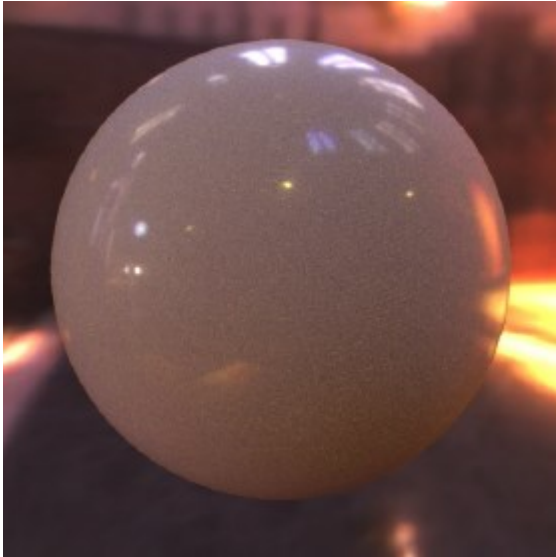

Appearance

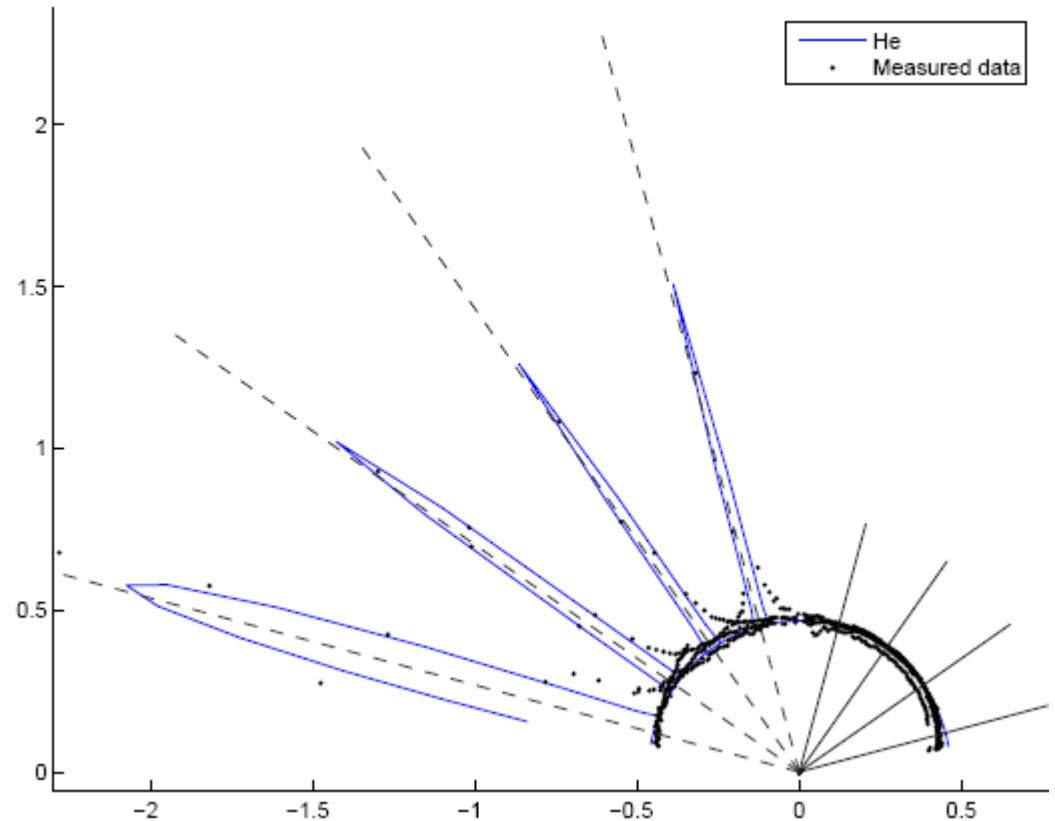

BRDF lobe  
(for four different viewing directions)

# Surface appearance and the BRDF

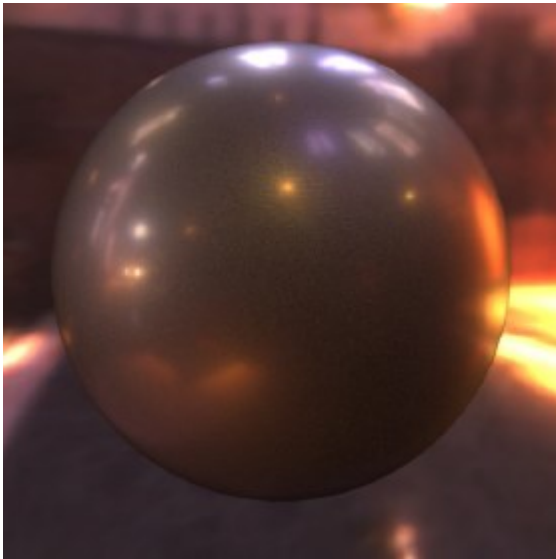

Appearance

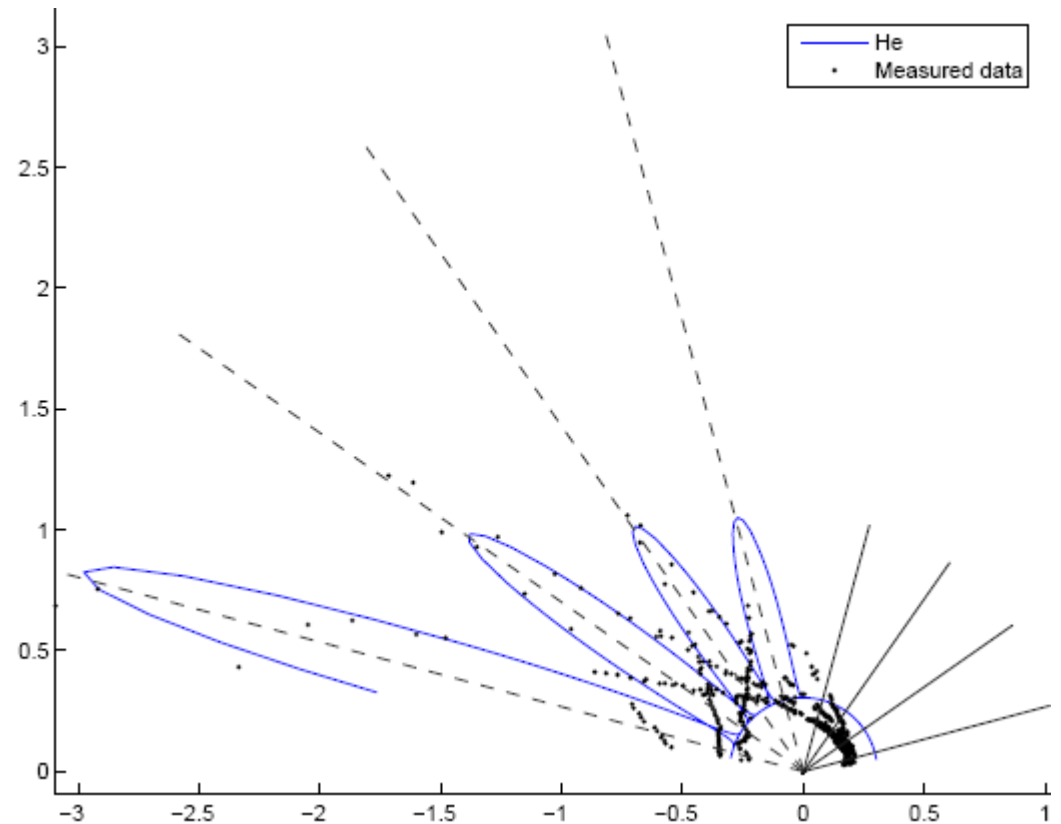

BRDF lobe  
(for four different viewing directions)

# Surface appearance and the BRDF



Appearance

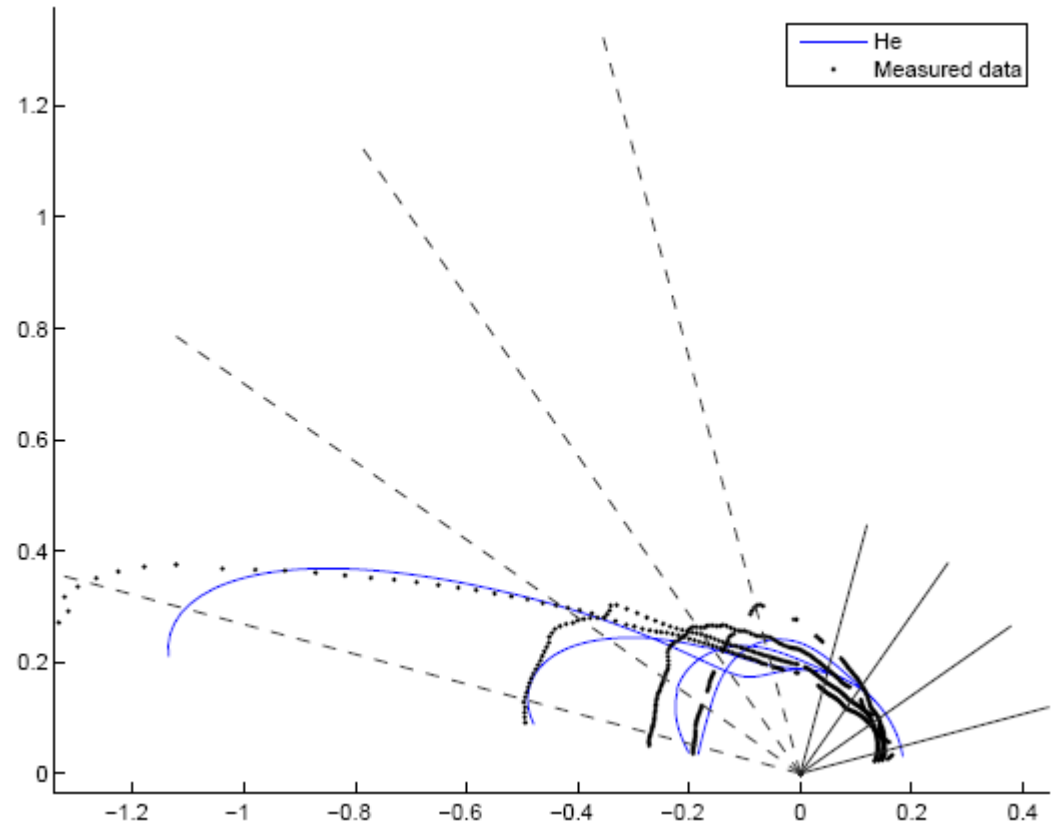

BRDF lobe  
(for four different viewing directions)

# Surface appearance and the BRDF

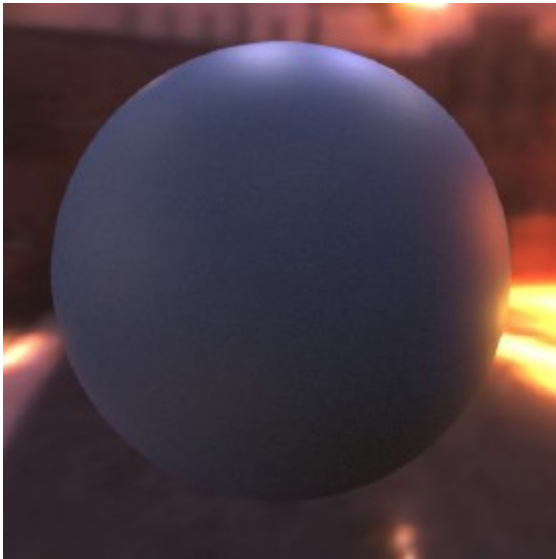

Appearance

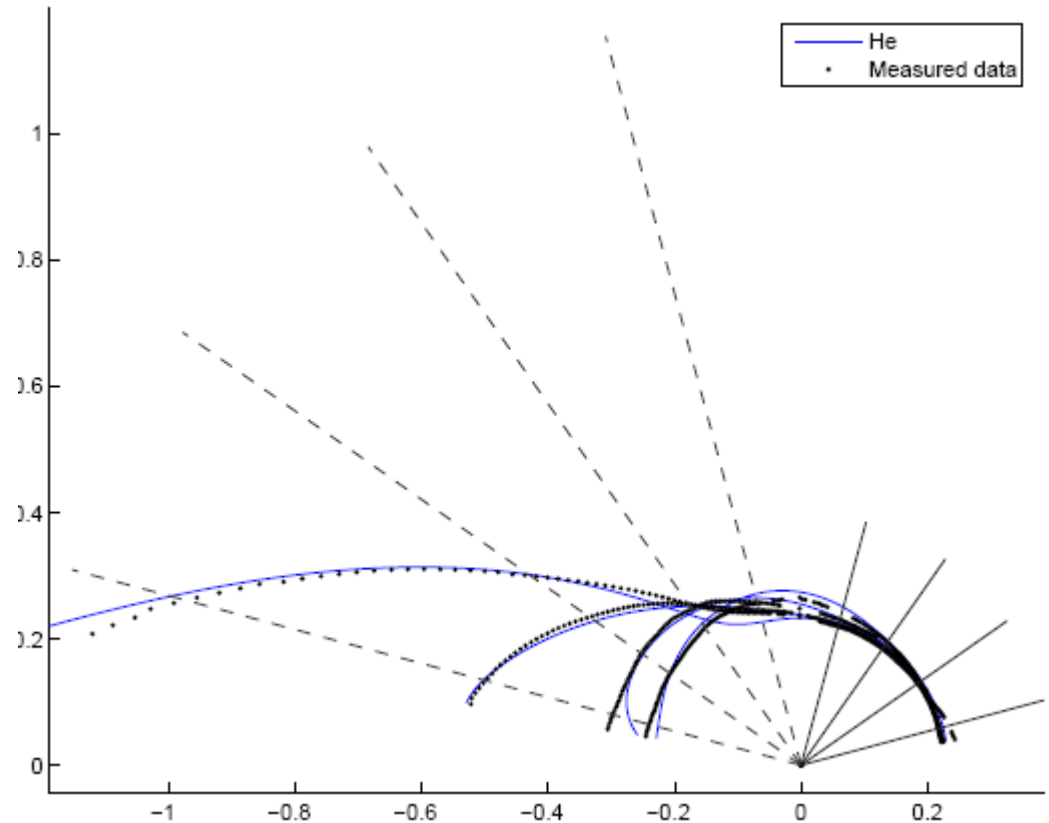

BRDF lobe  
(for four different viewing directions)

# Reflectance

- Ratio of the **incoming** and **outgoing flux**
  - A.k.a. „albedo“ (used mostly for diffuse reflection)
- **Hemispherical-hemispherical** reflectance
  - See the “Energy conservation” slide
- **Hemispherical-directional** reflectance
  - The amount of light that gets reflected in direction  $\omega_o$  when illuminated by the unit, uniform incoming radiance.

$$\rho(\omega_o) = a(\omega_o) = \int_{H(\mathbf{x})} f_r(\omega_i \rightarrow \omega_o) \cos \theta_i \, d\omega_i$$

# Hemispherical-directional reflectance

- Nonnegative
  - Less than or equal to 1 (energy conservation)
- $$\rho(\omega_o) \in [0, 1]$$
- Equal to **directional-hemispherical reflectance**
    - What is the percentage of the energy coming from the incoming direction  $\omega_i$  that gets reflected (to any direction)?“
    - Equality follows from the Helmholtz reciprocity

# Albedo

---

- ◆ fraction of light reflected from a diffuse surface
  - usually refers to an average across the visible spectrum

- ◆ examples

- clouds 80%
- fresh snow 80%
- old snow 40%
- grass 30%
- soil 15%
- rivers 7%
- ocean 3%

equality explains  
“whiteout” in blizzards

not including mirror  
reflections of the sun



# Diffuse albedo and total reflectance measurements

Jaroslav Křivánek  
Nov 09, 2009

Procedure briefly described on page 2.

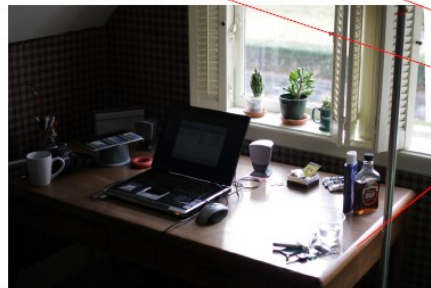
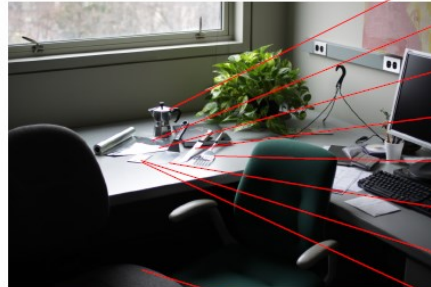

object / material	diffuse albedo (%)	total reflectance (%) (very approximate)
bialetti espresso maker (brand new)	3.2	90
aluminum foil top	1.2	90
aluminum foil bottom	2.9	85
knife blade	1.4	60
spatula (chrome)	0.9	85
pizza spatula (scratched)	2.2	60
rhodes light switch cover - top (coarse finish - aniso)	2.7 / 9.3 *	50
rhodes light switch cover - bottom (polished)	1.0	70
chair upholstery	from (6.5, 6, 5.5) to (13, 12, 11)	
plant leaf	green from (6, 12, 5) to (11, 18, 8) yellow from (27, 36, 19) to (31, 42, 16)	
rhodes office desk	(35, 35, 34)	
plastic cup		
notebook paper (yellowish)	(89, 80, 71)	
plate	(83, 81, 71)	
paper plate	(82, 80, 78)	
wood	from (50, 30, 19) to (80, 53, 34)	
rhodes office wall paint	(64, 60, 51)	
rhodes office door paint	(24, 25, 22)	
file cabinet (gray paint)	(6.6, 6.6, 6.4)	
rhodes carpet	(18, 15, 13)	
dark reddish wood	from (18, 9, 4) to (33, 17, 8)	
milos's thesis binding	2.8	
canon lens cap (black plastic)	2.7	
cornell recycle bin (blue plastic)	(1, 5, 25)	

\* viewing along scratches / perpendicular to scratches

# BRDF components

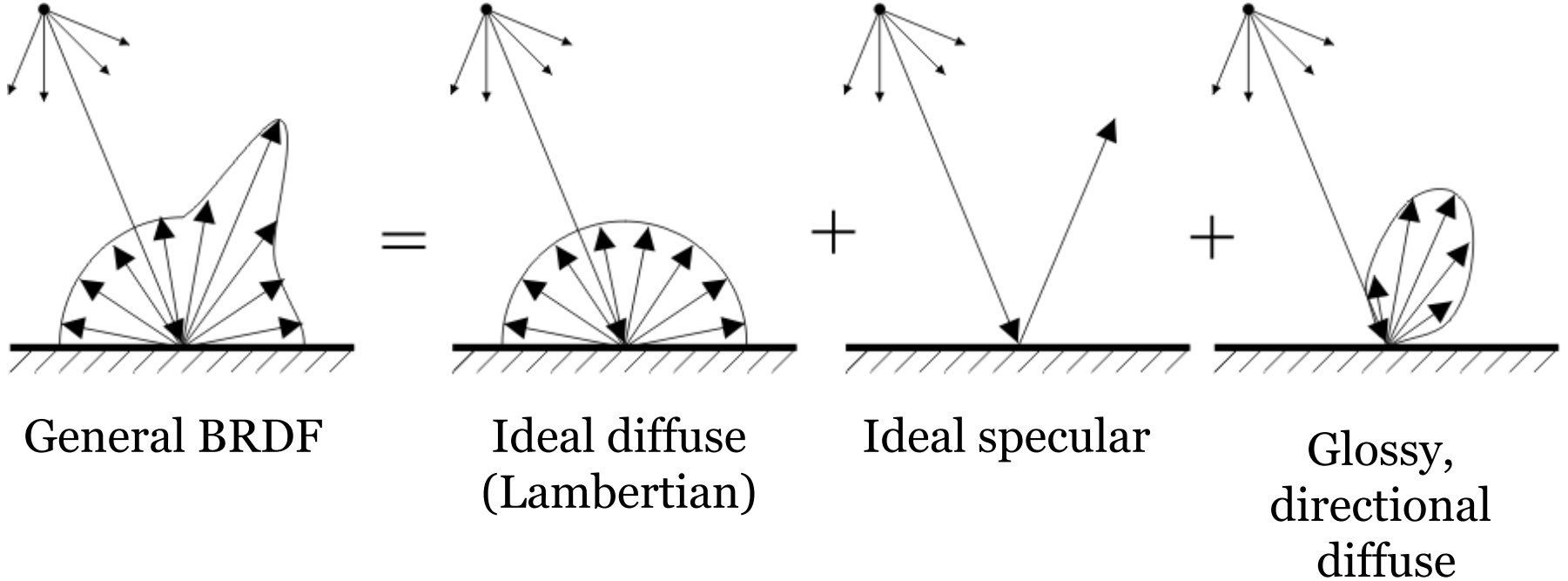

---

# **Ideal diffuse reflection**

---

# Ideal diffuse reflection

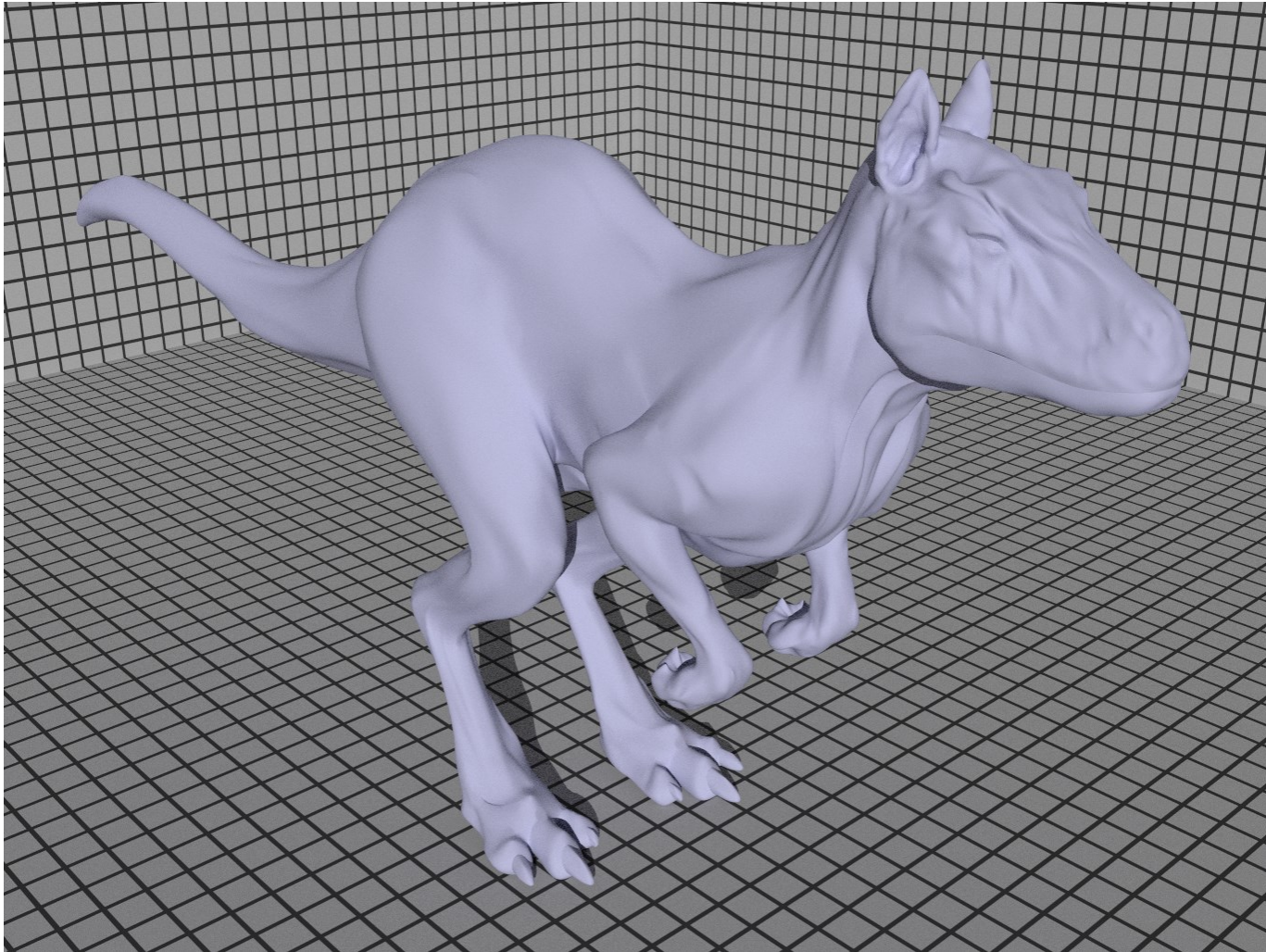

# Ideal diffuse reflection

- A.k.a. Lambertian reflection

- Johann Heinrich Lambert, „Photometria“, 1760.

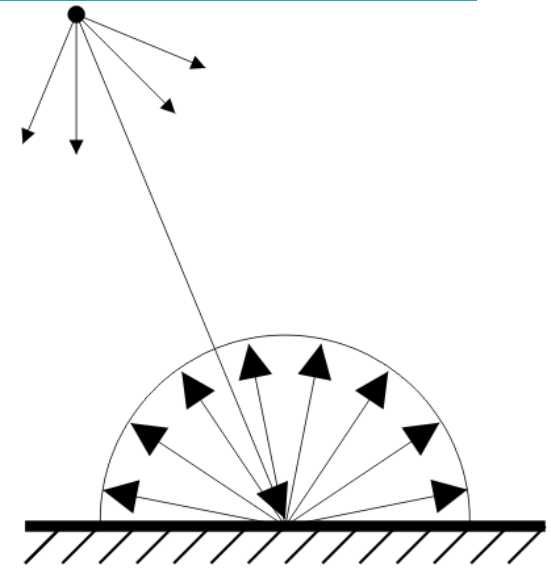

- Postulate: Light gets reflected to all directions with the same probability, irrespective of the direction it came from
- The corresponding BRDF is a constant function (independent of  $\omega_i$ ,  $\omega_o$ )

$$f_{r,d}(\omega_i \rightarrow \omega_o) = f_{r,d}$$

# Ideal diffuse reflection

- Reflection on a Lambertian surface:

$$\begin{aligned} L_o(\omega_o) &= f_{r,d} \int_{H(\mathbf{x})} L_i(\omega_i) \cos \theta_i \, d\omega_i \\ &= f_{r,d} E \end{aligned}$$

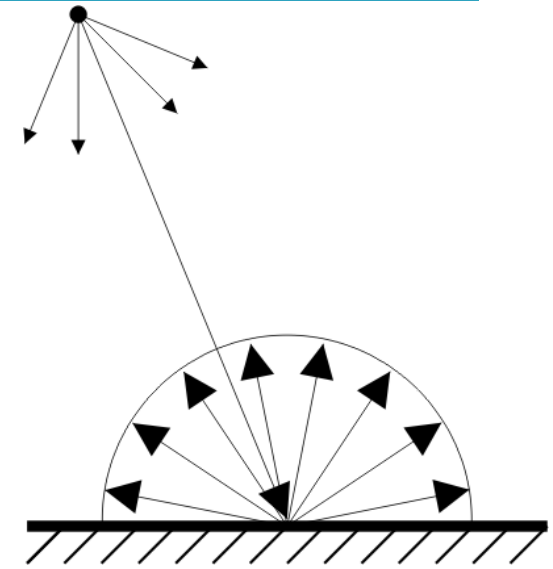

- **View independent appearance**

- Outgoing radiance  $L_o$  is independent of  $\omega_o$

- **Reflectance (derive)**

$$\rho_d = \pi \cdot f_{r,d}$$

irradiance

# Ideal diffuse reflection

- Mathematical idealization that does not exist in nature
- The actual behavior of natural materials deviates from the Lambertian assumption especially for grazing incidence angles

# White-out conditions

- Under a covered sky we cannot tell the shape of a terrain covered by snow



- We do not have this problem close to a localized light source.

- **Why?**





# White-out conditions

- We assume sky radiance independent of direction (covered sky)

$$L_i(\mathbf{x}, \omega_i) = L^{\text{sky}}$$

- We also assume Lambertian reflection on snow

- Reflected radiance given by:

$$L_o^{\text{snow}} = \rho_d^{\text{snow}} \cdot L_i^{\text{sky}}$$

White-out!!!

---

# **Ideal mirror reflection**

---

# Ideal mirror reflection

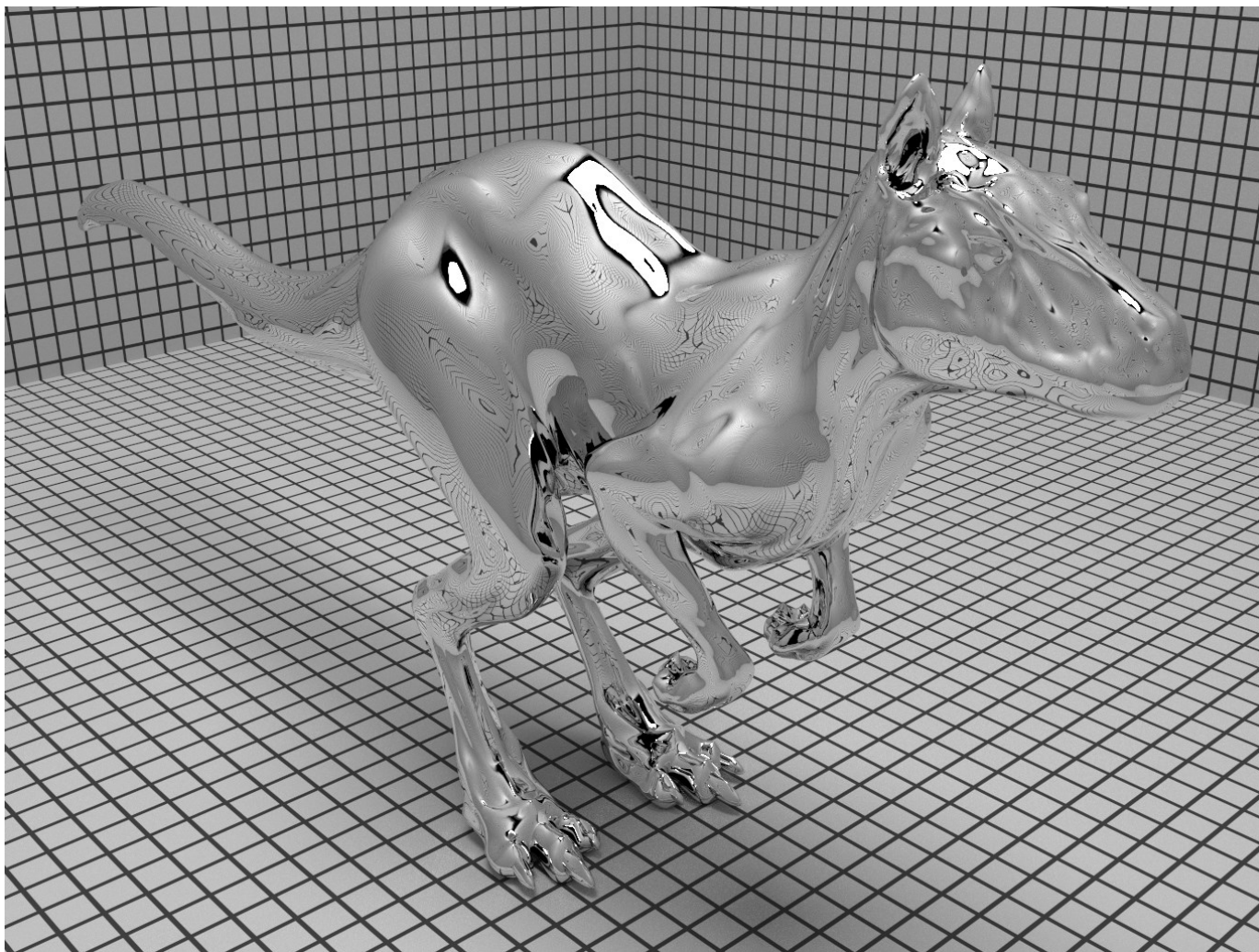

## Reflections From the Surface of Water

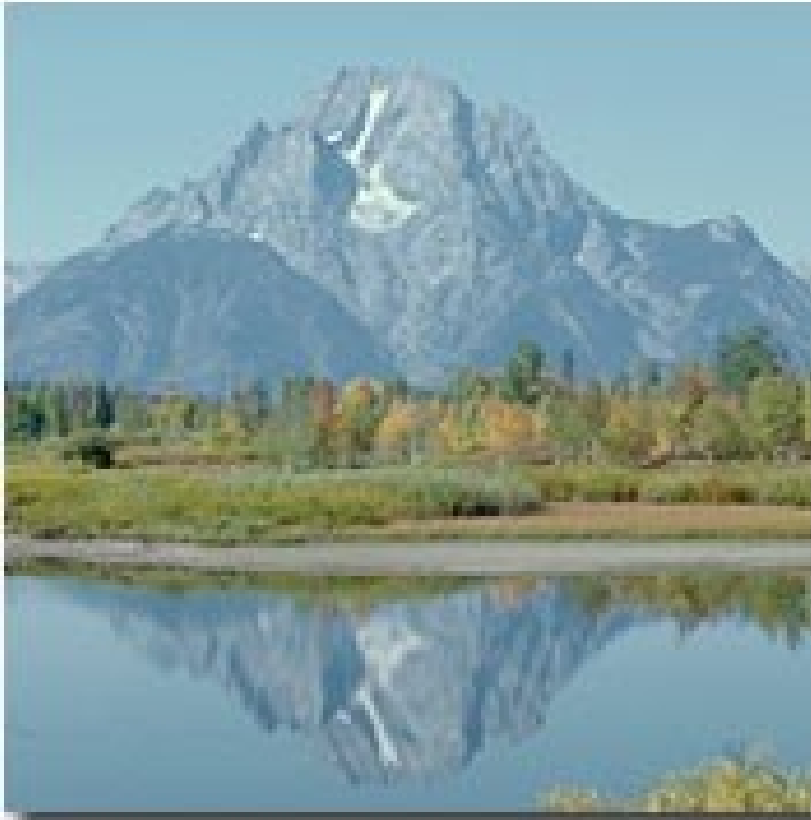

**Smooth Water Surface**



**Wavy Water Surface**



# The law of reflection

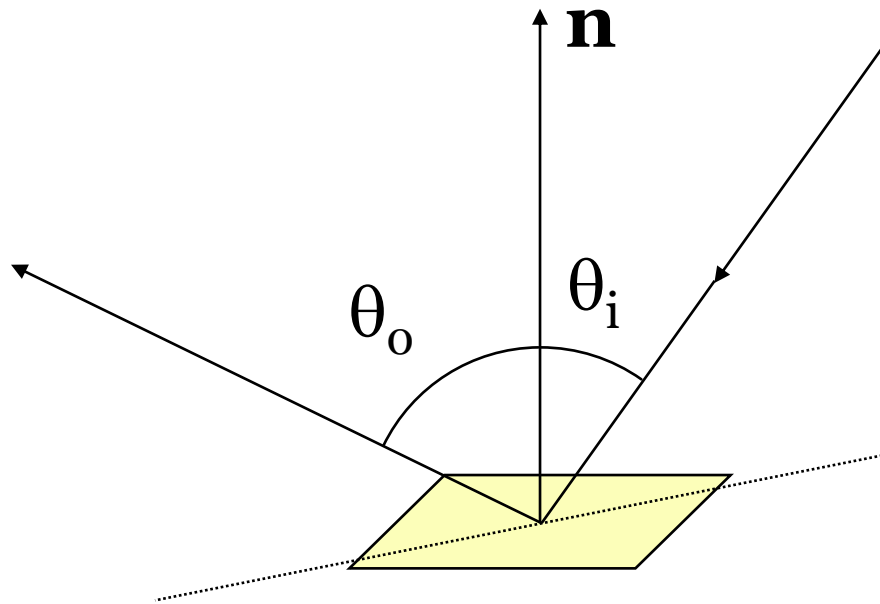

$$\theta_o = \theta_i$$

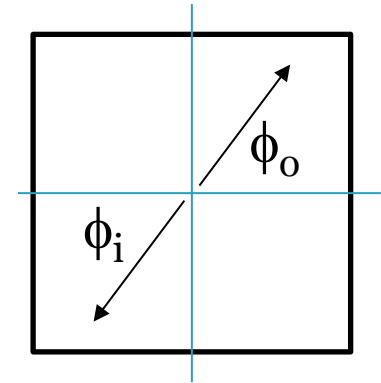

$$\phi_o = (\phi_i + \pi) \bmod 2\pi$$

- Direction of the reflected ray (derive the formula)

$$\omega_o = 2(\omega_i \cdot \mathbf{n})\mathbf{n} - \omega_i$$

# Digression: Dirac delta distribution

- **Definition** (informal):

$$\delta(x) = \begin{cases} +\infty, & x = 0 \\ 0, & x \neq 0 \end{cases}$$

$$\int_{-\infty}^{\infty} \delta(x) dx = 1.$$

- The following holds for any  $f$ :

$$\int_{-\infty}^{\infty} f(x)\delta(x) dx = f(0)$$

- Delta distribution is **not a function** (otherwise the integrals would = 0)

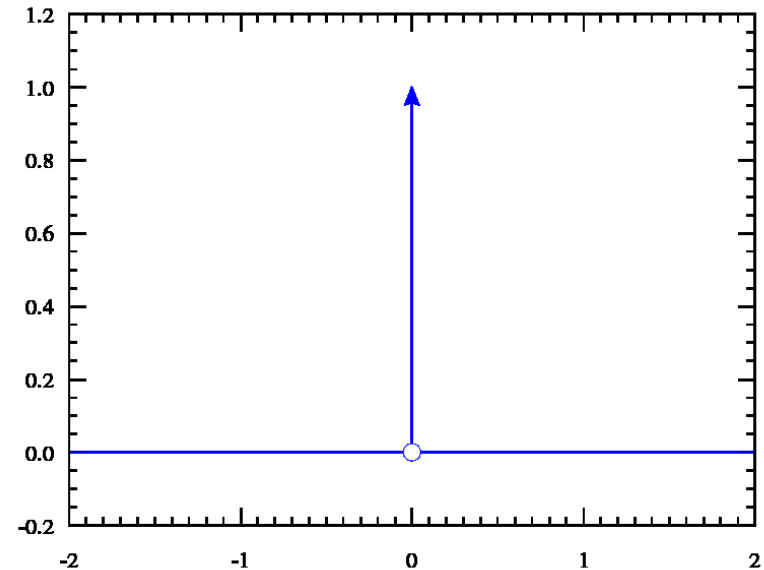
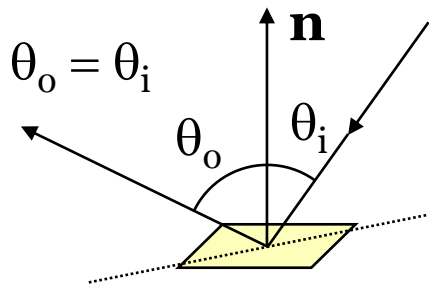

Image: Wikipedia

# BRDF of the ideal mirror

- BRDF of the ideal mirror is a Dirac delta distribution



We want:

$$L_r(\theta_o, \varphi_o) = R(\theta_i) L_i(\theta_o, \varphi_o \pm \pi)$$

Fresnel reflectance (see below)

$$f_{r,m}(\theta_i, \varphi_i; \theta_o, \varphi_o) = R(\theta_i) \frac{\delta(\cos \theta_i - \cos \theta_o) \delta(\varphi_i - \varphi_o \pm \pi)}{\cos \theta_i}$$



# BRDF of the ideal mirror

- BRDF of the ideal mirror is a Dirac delta distribution
- Verification:

$$\begin{aligned}L_r(\theta_o, \varphi_o) &= \int f_{r,m}(\cdot) L_i(\cdot) \cos \theta_i d\omega_i \\ &= \int R(\theta_i) \frac{\delta(\cos \theta_i - \cos \theta_o) \delta(\varphi_i - \varphi_o \pm \pi)}{\cos \theta_i} L_i(\theta_i, \varphi_i) \cos \theta_i d\omega_i \\ &= R(\theta_i) L_i(\theta_r, \varphi_r \pm \pi)\end{aligned}$$



Diego Velázquez,  
Venus at her  
Mirror, 1647

Q. Who is Venus looking at in the mirror?

---

# **Ideal refraction**

---

# Ideal refraction

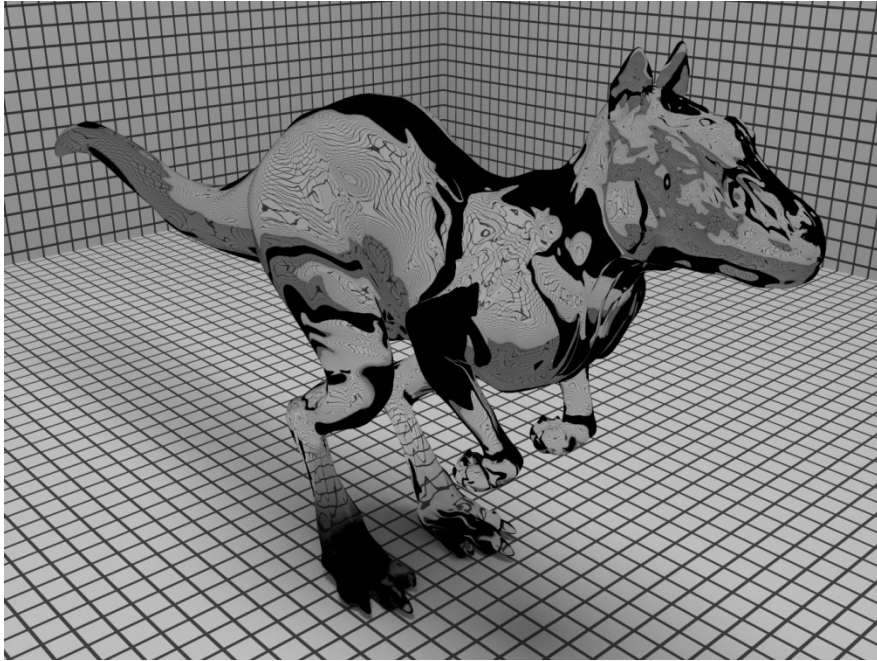

# Ideal refraction

- **Index of refraction  $\eta$**

- Water 1.33, glass 1.6, diamond 2.4
- Often depends on the wavelength

- **Snell's law**

$$\eta_i \sin \theta_i = \eta_o \sin \theta_o$$

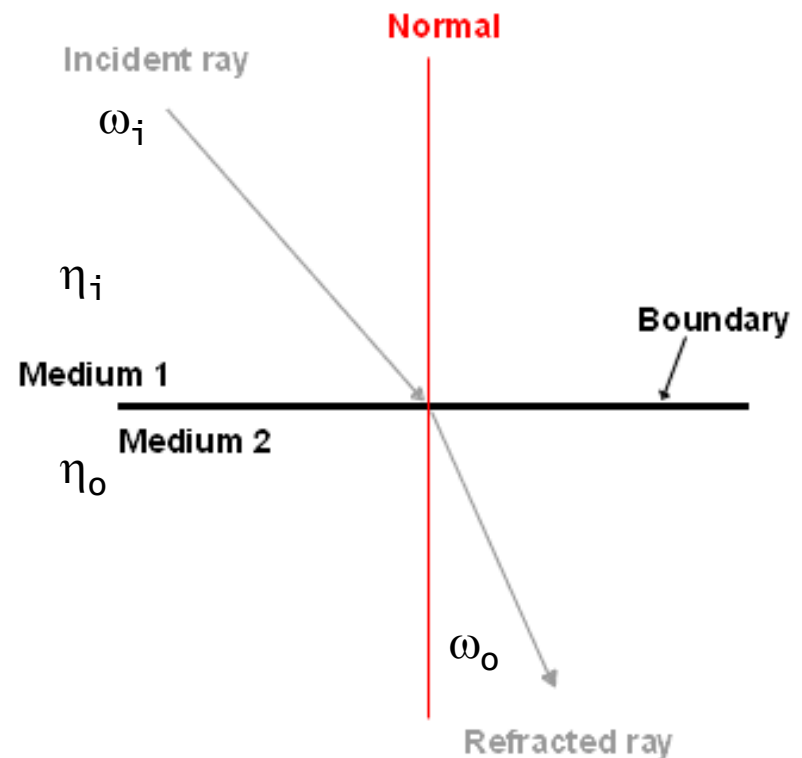

# Ideal refraction

- **Direction of the refracted ray:**

$$\omega_o = -\eta_{io}\omega_i - \underbrace{\left(\eta_{io} \cos \theta_i + \sqrt{1 - \eta_{io}^2 (1 - \cos^2 \theta_i)}\right)}_{\text{if } < 0, \text{ total internal reflection}} \mathbf{n}$$

$$\eta_{io} = \frac{\eta_i}{\eta_o}$$

if  $< 0$ , **total internal reflection**

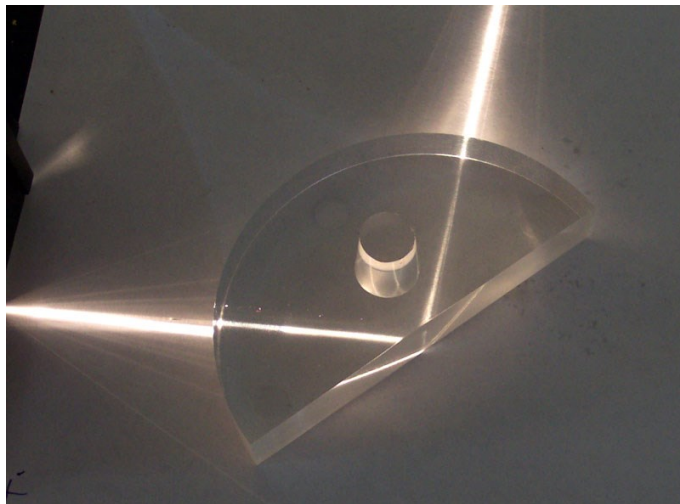

Image: wikipedia

**Critical angle:**

$$\theta_{i,c} = \arcsin\left(\frac{\eta_o}{\eta_i}\right)$$

# Ideal refraction

## ■ Change of radiance

- Follows from the conservation of energy (flux)
- When going from an optically rarer to a more dense medium, light energy gets “compressed” in directions => higher energy density => higher radiance

$$L_o = L_i \frac{\eta_o^2}{\eta_i^2}$$

# BRDF of ideal refraction

- BRDF of the ideal refraction is a delta distribution:

Change of radiance

Fresnel transmittance

Snell's law

$$f_t(\theta_i, \varphi_i; \theta_o, \varphi_o) = \frac{\eta_o^2}{\eta_i^2} (1 - R(\theta_i)) \frac{\delta(\eta_i \sin \theta_i - \eta_o \sin \theta_o) \delta(\varphi_i - \varphi_o \pm \pi)}{\cos \theta_i}$$

Refracted ray stays in the incidence plane



---

# Fresnel equations

---

# Fresnel equations



- Read [frenel]
- Ratio of the transmitted and reflected light depends on the incident direction
  - From above – more transmission
  - From the side – more reflection
- Extremely important for realistic rendering of glass, water and other smooth dielectrics
- Not to be confused with Fresnel lenses (used in lighthouses)



# Fresnel equations

## ■ Dielectrics

$$R_s = \left| \frac{n_1 \cos \theta_i - n_2 \cos \theta_t}{n_1 \cos \theta_i + n_2 \cos \theta_t} \right|^2$$

$$R_p = \left| \frac{n_1 \cos \theta_t - n_2 \cos \theta_i}{n_1 \cos \theta_t + n_2 \cos \theta_i} \right|^2$$

$$R = \frac{R_s + R_p}{2}$$

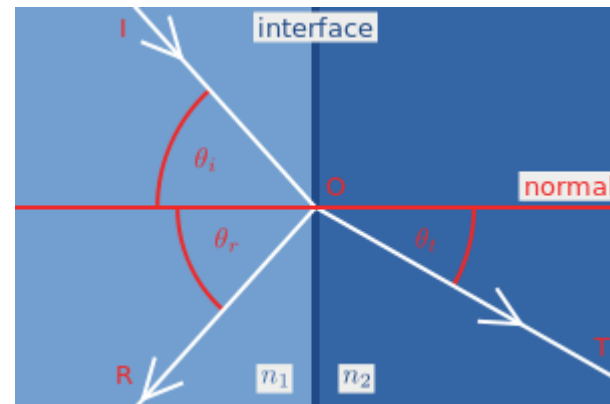
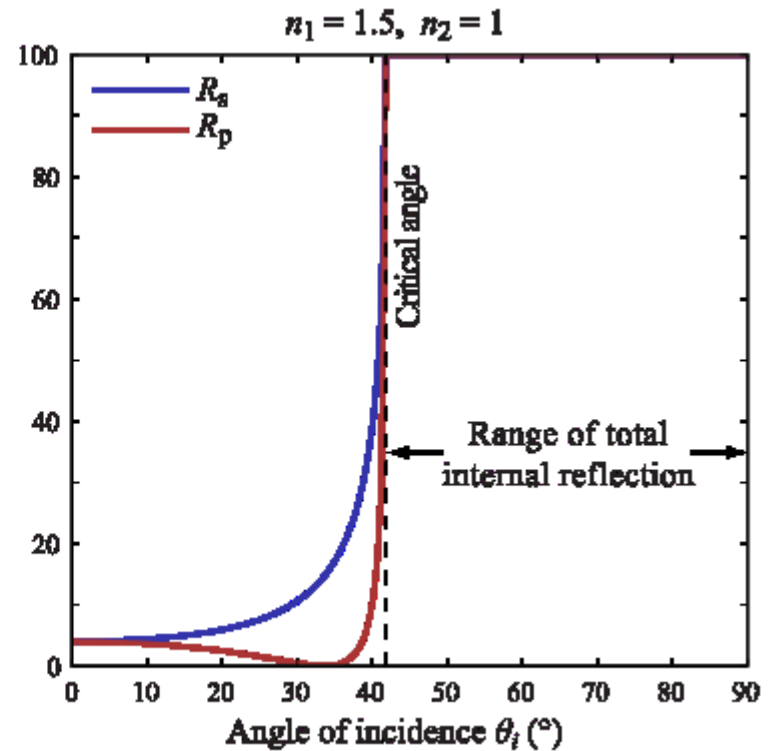
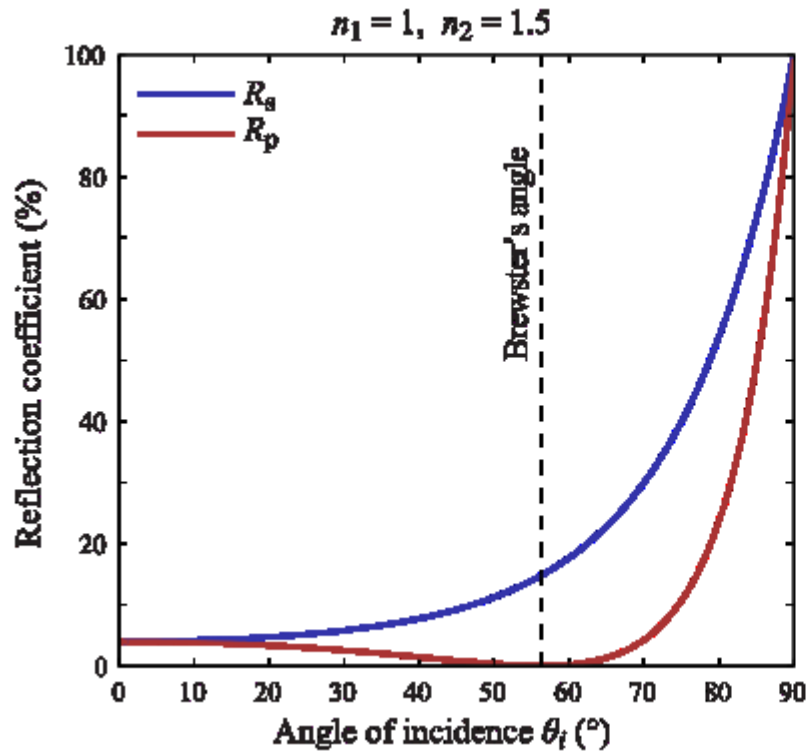

Image: Wikipedia

# Fresnel equations

## ■ Dielectrics



# Fresnel equations



From the side

- little transmission
- more reflection

Try for yourself!!!

From above

- little reflection
- more transmission

# Fresnel equations

## ■ Metals

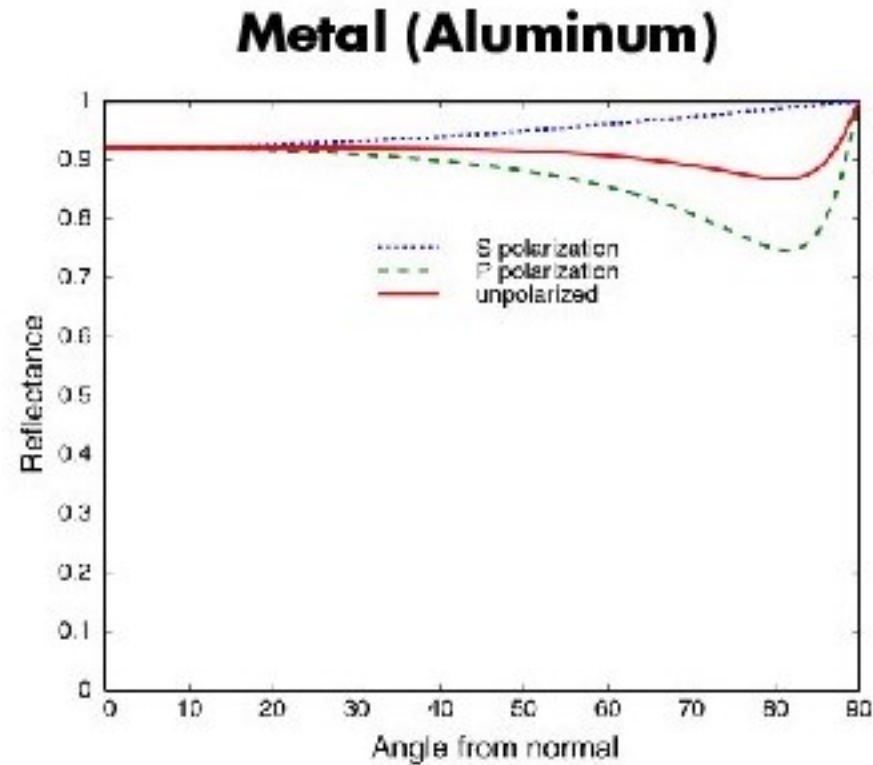

**Gold  $F(0)=0.82$**

**Silver  $F(0)=0.95$**

# Fresnel Lens

---

- ◆ same refractive power (focal length) as a much thicker lens
- ◆ good for focusing light, but not for making images

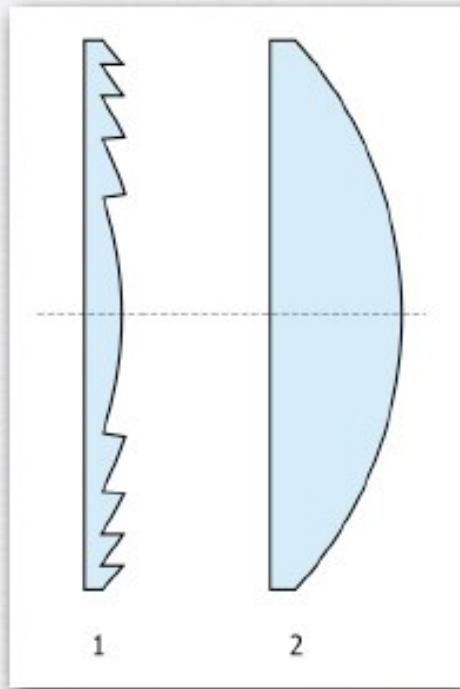

(wikipedia)



Tyler Westcott, Pigeon Point Lighthouse in light fog,  
photographed during the annual relighting of its historical 1KW lantern, 2008  
(Nikon D40, 30 seconds, ISO 200, not Photoshopped)



# Glossy reflection

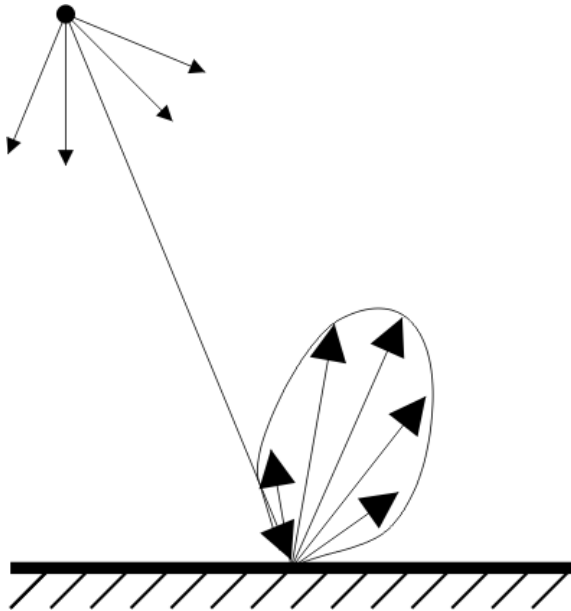

# Glossy reflection

- Neither ideal diffuse nor ideal mirror
- All real materials in fact fall in this category

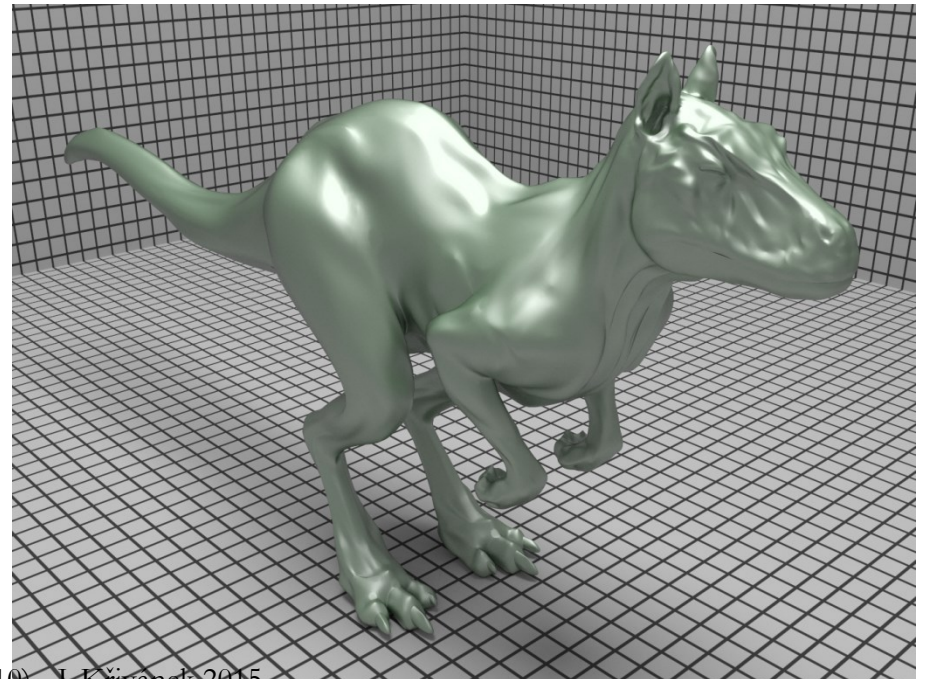
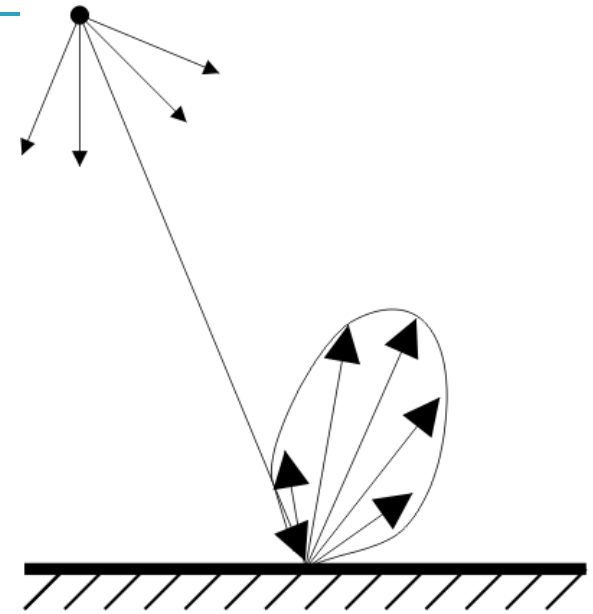

# Surface roughness and blurred reflections

- The rougher the blurrier



Microscopic surface roughness

# What unusual material property does this goniometric diagram depict?

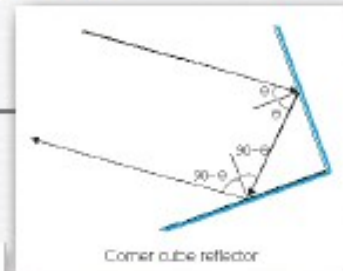

a full moon is roughly lit from the camera's viewpoint

so is a flash photograph

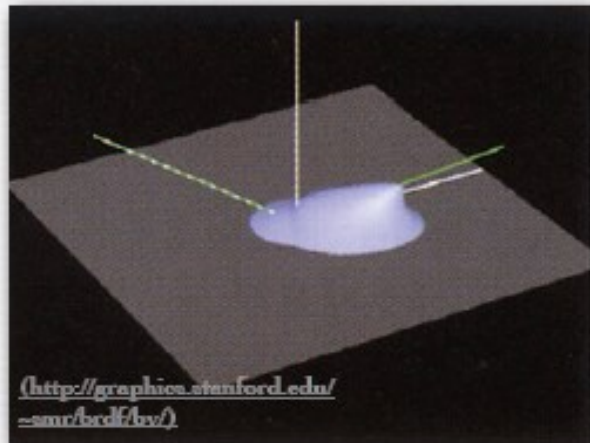

- ◆ A. retroreflectivity
- ◆ the maria of the moon is retroreflective and gray
- ◆ a diffuse object, lit from the camera's viewpoint, falls off as  $\cos \theta$

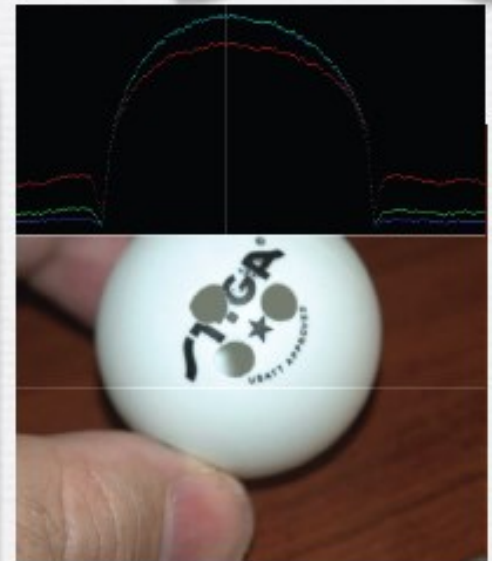
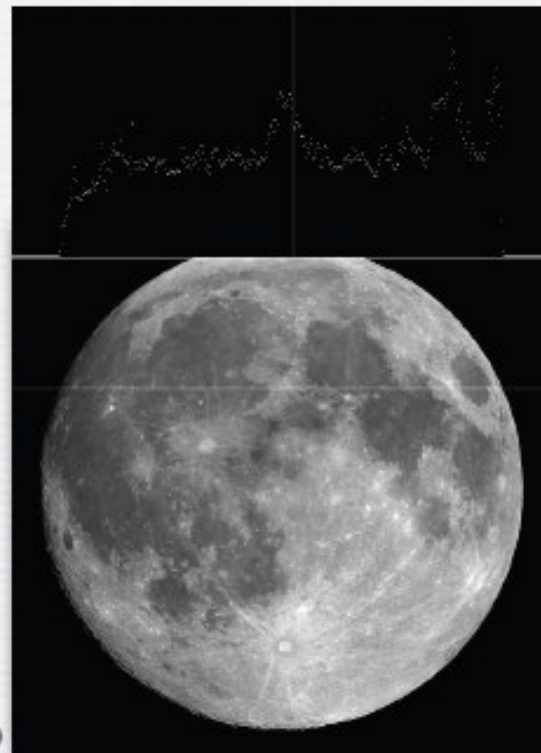

(NASA)

---

# **BRDF models**

---

# BRDF modeling

- BRDF is a model of the bulk behavior of light when viewing a surface from distance
- **BRDF models**
  - Empirical
  - Physically based
  - Approximation of measured data

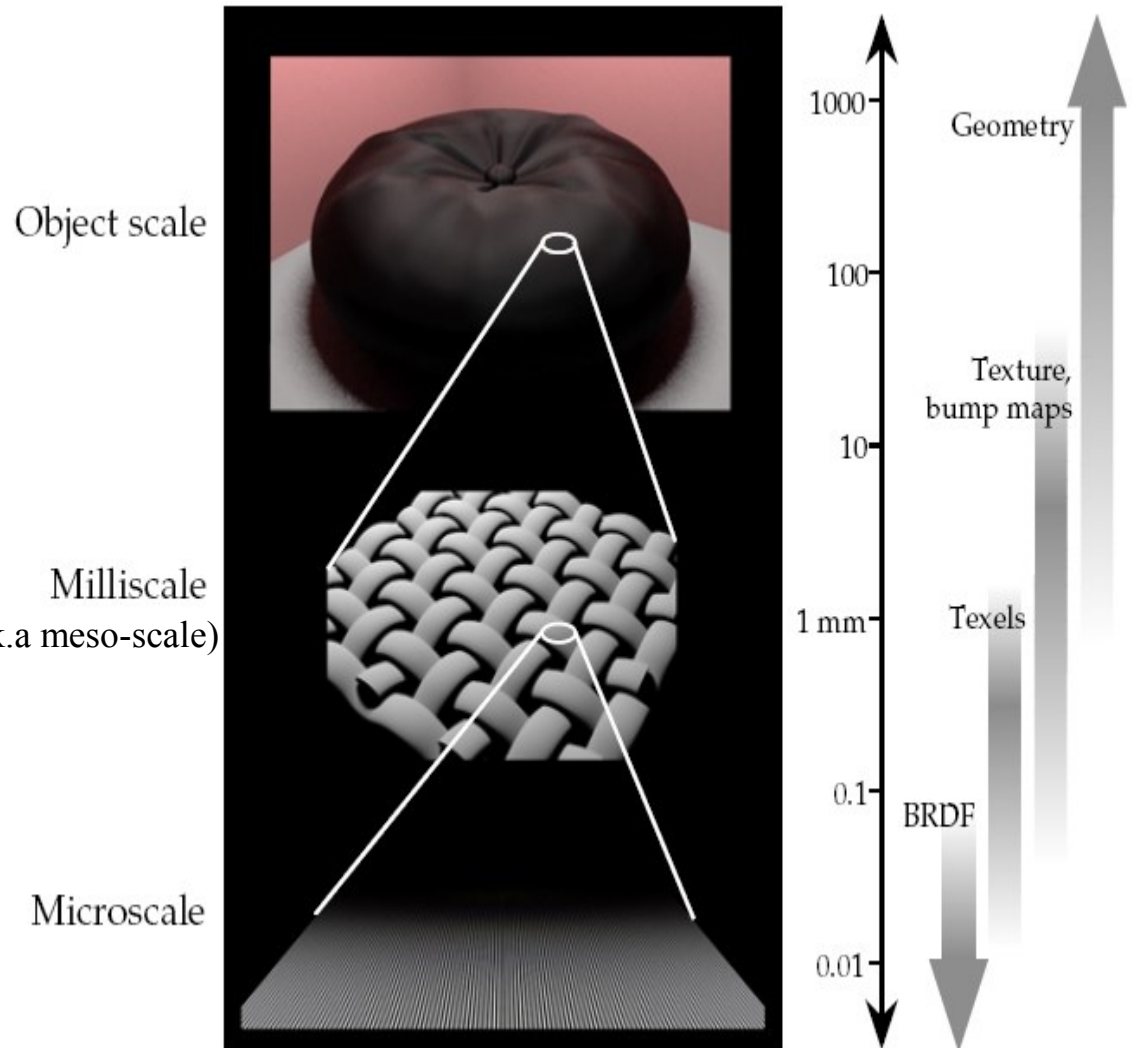

# Empirical BRDF models

- An arbitrary formula that takes  $\omega_i$  and  $\omega_o$  as arguments
- $\omega_i$  and  $\omega_o$  are sometimes denoted  $L$  (**L**ight direction) a  $V$  (**V**iewing direction)
- Example: Phong model
- Arbitrary shading calculations (shaders)

# Phong shading model

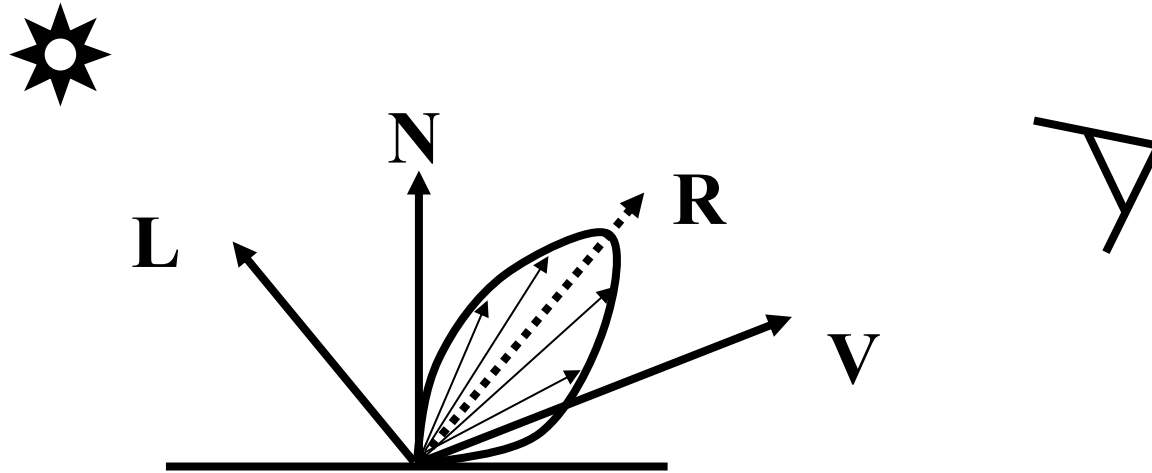

$$C = I \left( k_d (N \cdot L) + k_s (V \cdot R)^n \right)$$

$$R = 2(N \cdot L)N - L$$



# Phong shading model in the radiometric notation

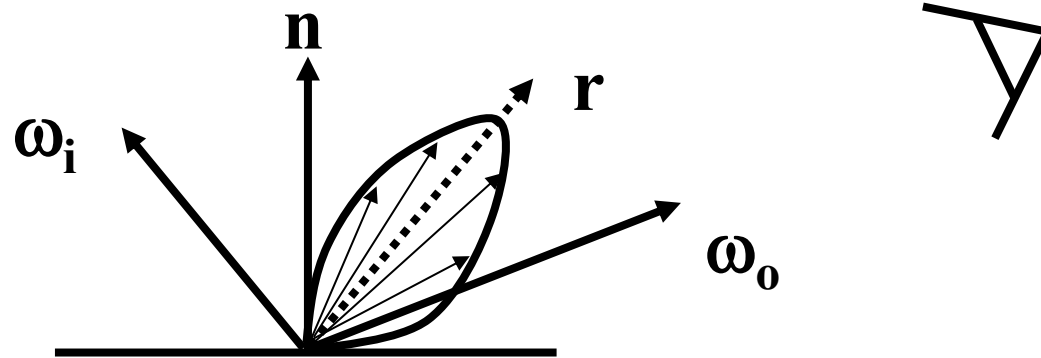

Original shading model

$$L_o(\omega_o) = L_i(\omega_i) (k_d \cos \theta_i + k_s \cos^n \theta_r)$$

$$\cos \theta_r = \omega_o \cdot \mathbf{r} \quad \mathbf{r} = 2(\mathbf{n} \cdot \omega_i) \mathbf{n} - \omega_i$$

BRDF  $f_r = \frac{L_o}{L_i \cos \theta_i}$

$$f_r^{PhongOrig} = k_d + k_s \frac{\cos^n \theta_r}{\cos \theta_i}$$

# Physically-plausible Phong BRDF

- Modification to ensure reciprocity (symmetry) and energy conservation

$$f_r^{\text{Phongmodif}} = \frac{\rho_d}{\pi} + \frac{n+2}{2\pi} \rho_s \cos^n \theta_r$$

- Energy conserved when

$$\rho_d + \rho_s \leq 1$$

- It is still an empirical formula (i.e. it does not follow from physical considerations), but at least it fulfills the basic properties of a BRDF

# Physically-plausible BRDF models

- E.g. Torrance-Sparrow / Cook-Torrance model
- Based on the microfacet theory

# Reflection of the Sun from the Sea

---

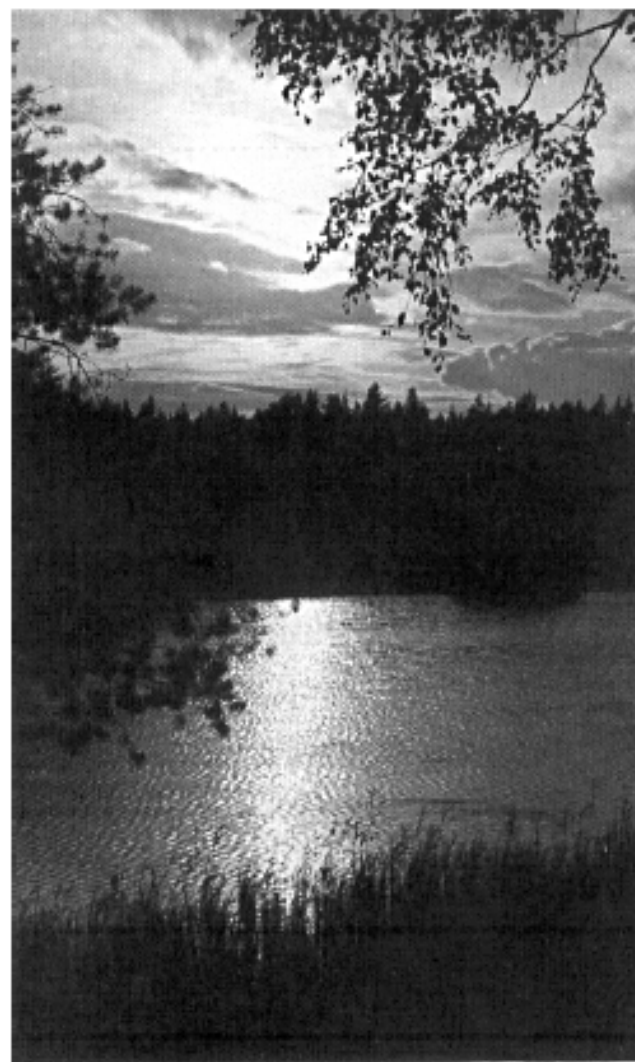

Minnaert, *Light and Color in the Outdoors*, p. 28

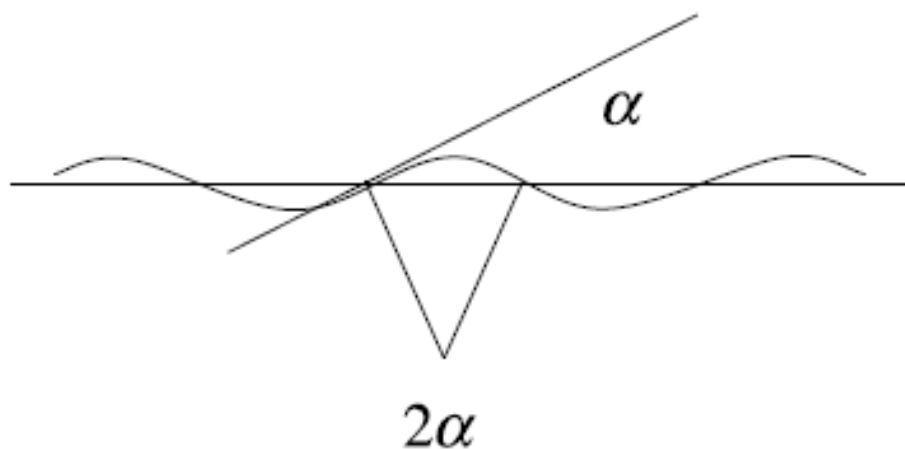

# Microfacet BRDF

- Analytically derived
- Used for modeling glossy surfaces (as the Phong model)
  - Corresponds more closely to reality than Phong
  - Derived from a physical model of the surface microgeometry (as opposed to “because it looks good”- approach used for the Phong model)

# Microfacet BRDF

- Assumes that the macrosurface consists of randomly oriented microfacets



- We assume that each microfacet behaves as an ideal mirror.
- We consider 3 phenomena:

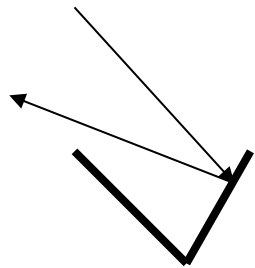

Reflection

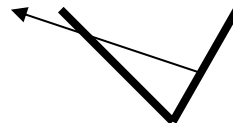

Masking

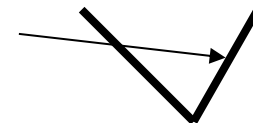

Shadowing

# Microfacet BRDF

## Microfacet theory [[Cook et Torrance 1982](#)]

### A perfect mirror

- Reflection in a single direction
- Outgoing light visible surface normal aligned with the half vector
- Half Vector:  $H = \frac{L+V}{\|L+V\|}$

### Aggregation of micro-mirrors (micro-facets)

- Each micro-mirror have a micro-normal
- How many micro-mirror have their micro-normal aligned so that  $H = N$  ?
- Statistical distribution: Normal Distribution Function (NDF)

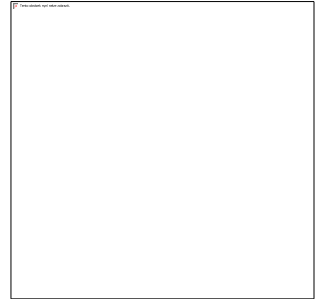

# Microfacet BRDF

**Fresnel term**

**Geometry term**

Models shadowing and masking

$$f = \frac{F(\theta_i)G(\omega_i, \omega_r)D(\theta_h)}{4 \cos(\theta_i) \cos(\theta_r)}$$

**Microfacet  
distribution**

Part of the  
macroscopic  
surface visible by  
the light source

Part of the  
macroscopic  
surface visible  
by the viewer



# Approximation of measured data

- We can fit any BRDF model to the data
- Some BRDF models have been specifically designed for the purpose of fitting measured data, e.g. Ward BRDF, Lafortune BRDF
- **Nonlinear optimization** required to find the BRDF parameters

# BRDF measurements – Gonio-reflectometer

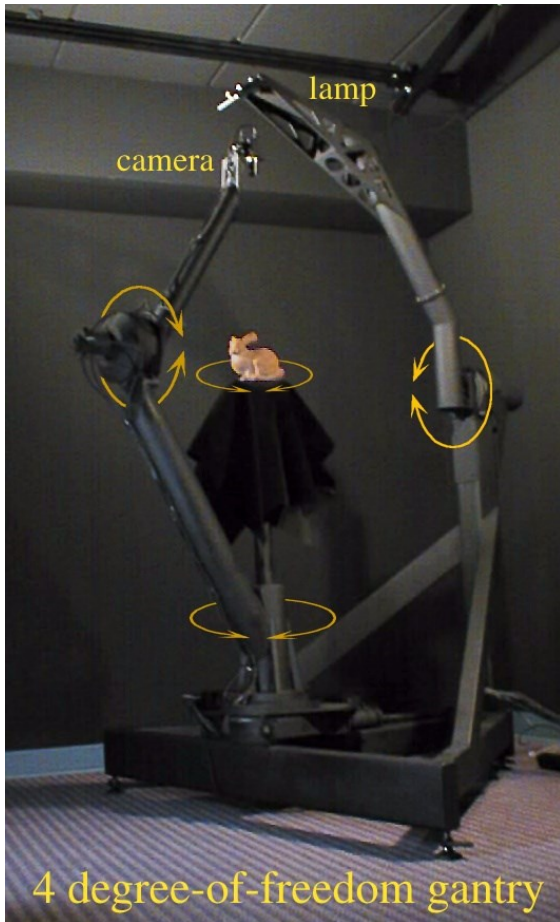

Stanford

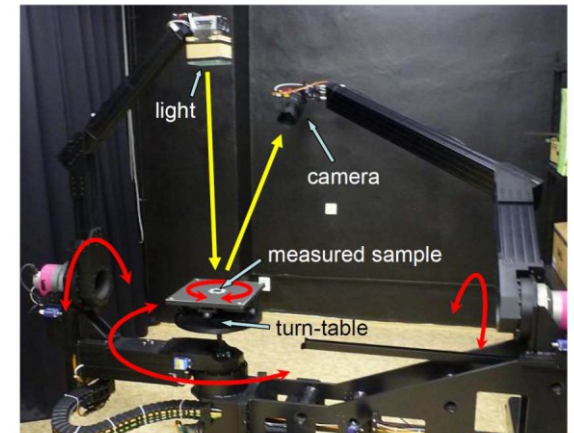
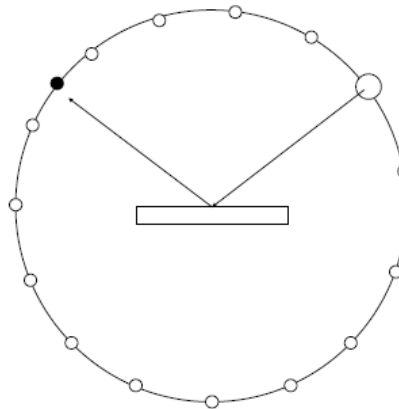

UTIA

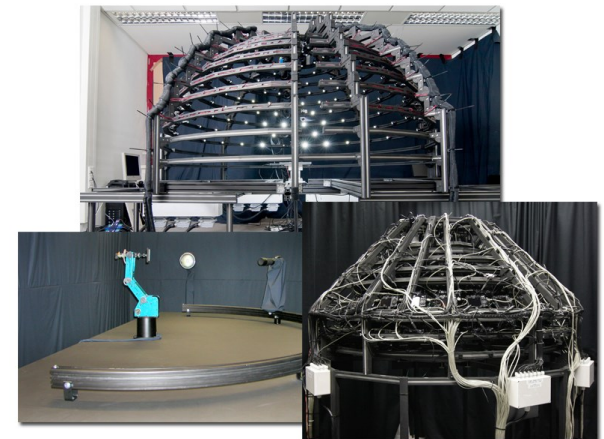

University of Bonn

# Measured Material

- Techniques for speeding measurements
  - Mirrors
  - Objects coated by the material:
    - Sphere [[Matusik et al 2003](#)]
    - Cylinders [[Ngan et al 2005](#)]



[[Matusik et al 2003](#)]

# Surface appearance and the BRDF

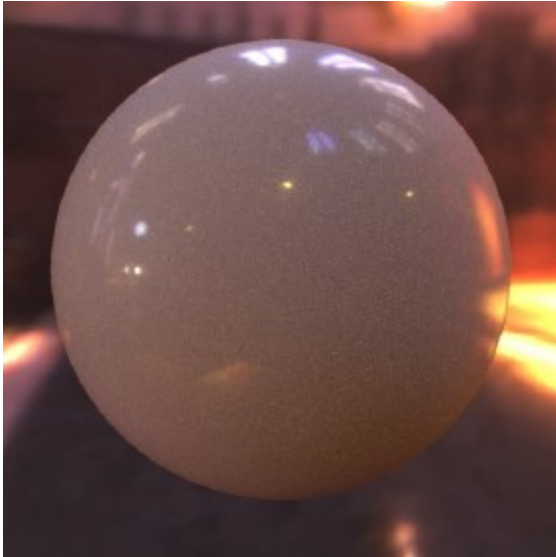

Appearance

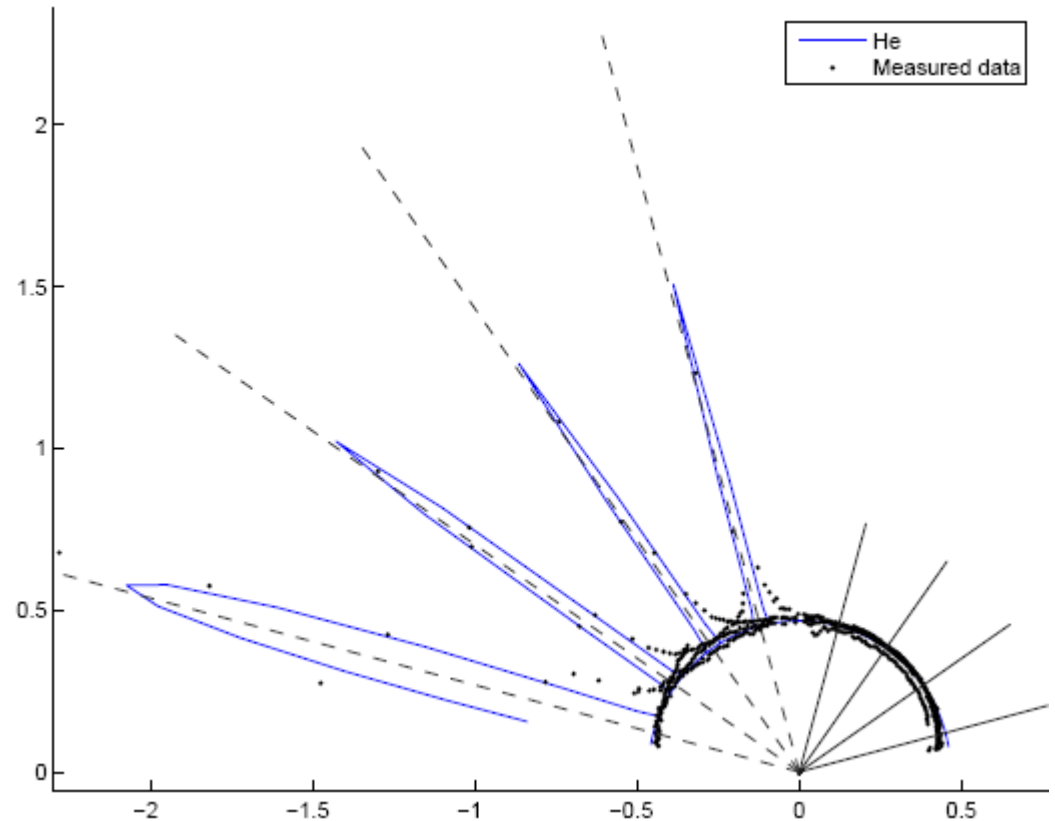

BRDF lobe  
(for four different viewing directions)

# Surface appearance and the BRDF

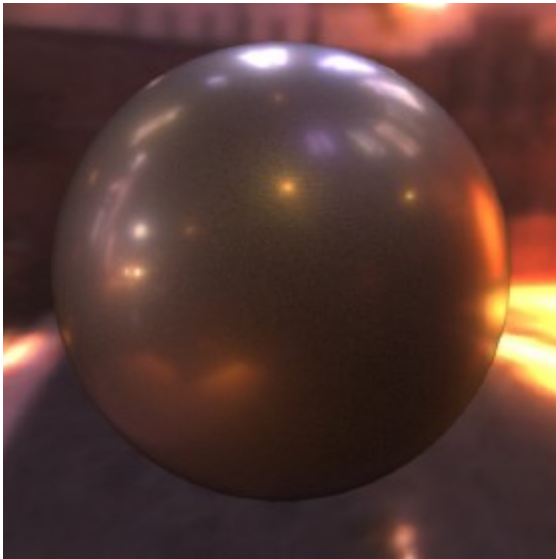

Appearance

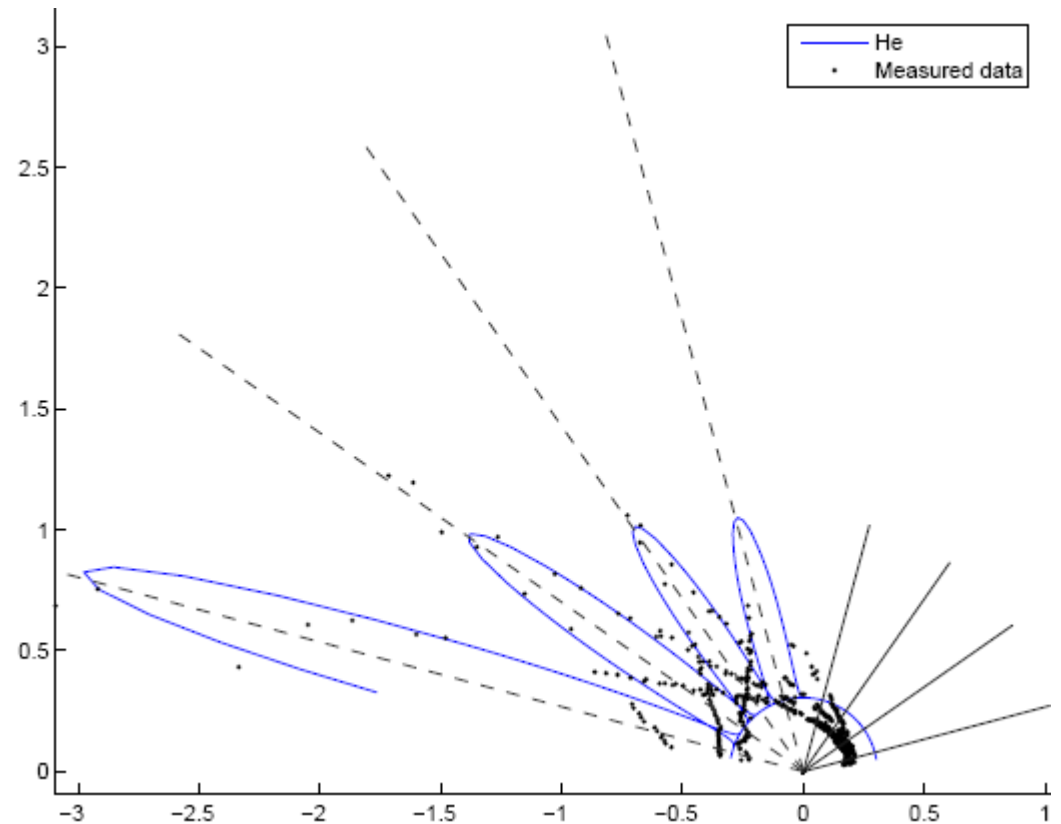

BRDF lobe  
(for four different viewing directions)

# Surface appearance and the BRDF



Appearance

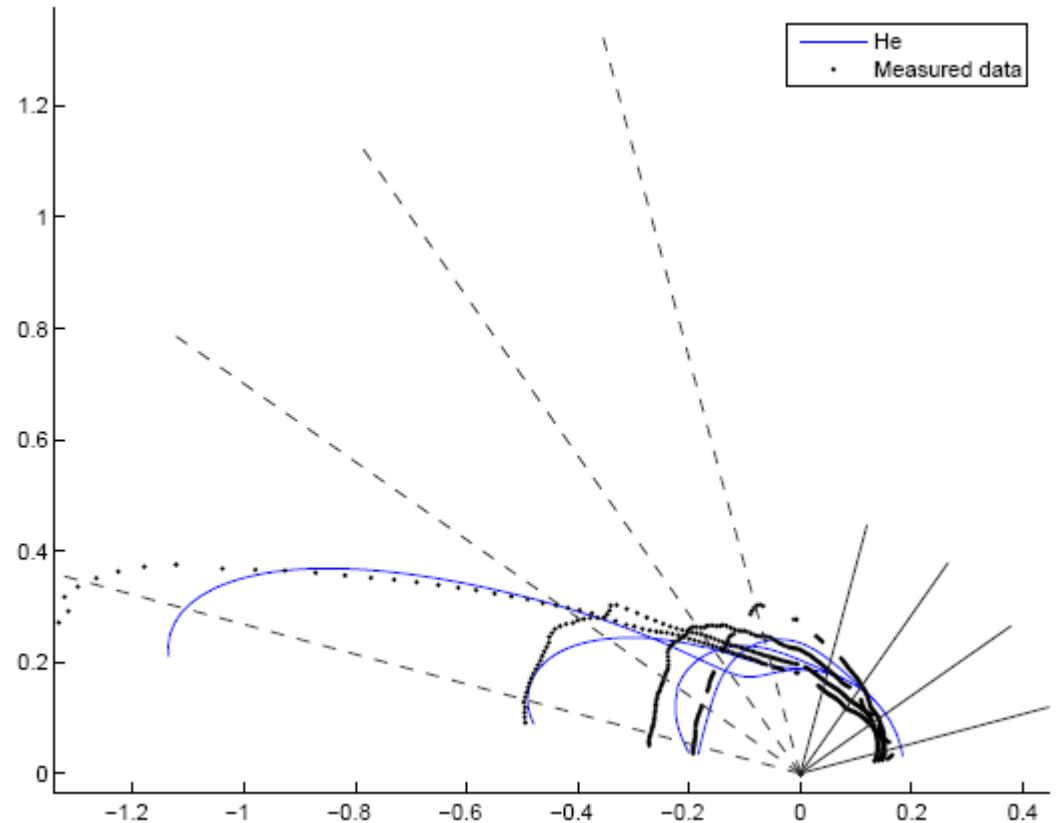

BRDF lobe  
(for four different viewing directions)

# Surface appearance and the BRDF

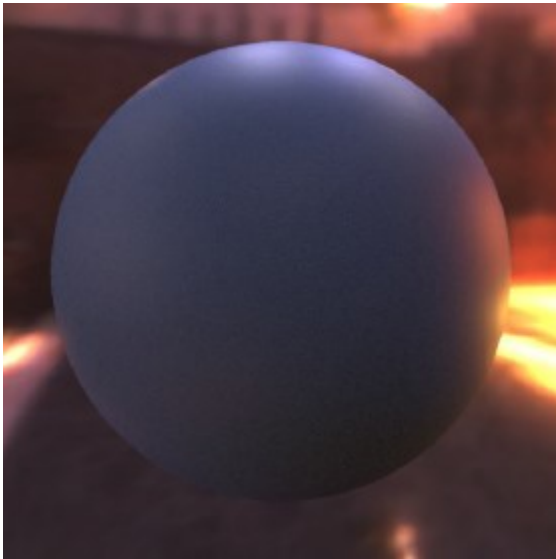

Appearance

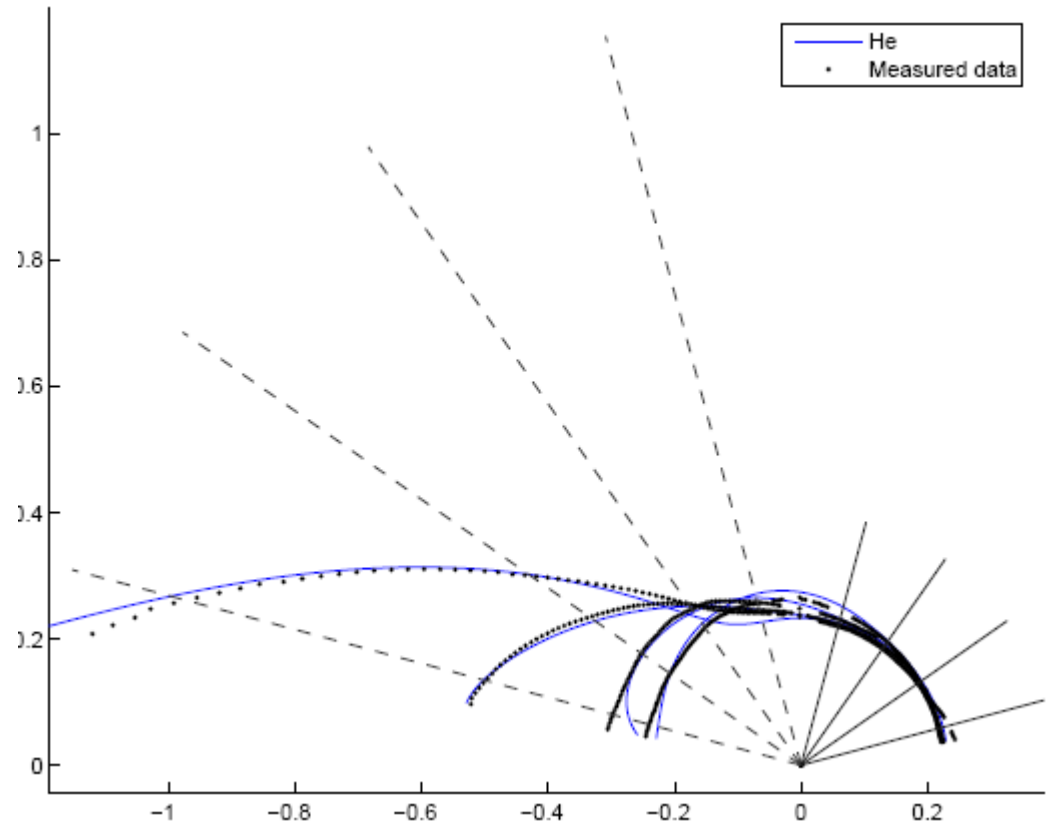

BRDF lobe  
(for four different viewing directions)

# BRDF, BTDF, BSDF: What's up with all these abbreviations?

- **BTDF**
  - ❑ Bidirectional **transmittance** distribution function
  - ❑ Described light transmission
- **BSDF = BRDF+BTDF**
  - ❑ Bidirectional **scattering** distribution function

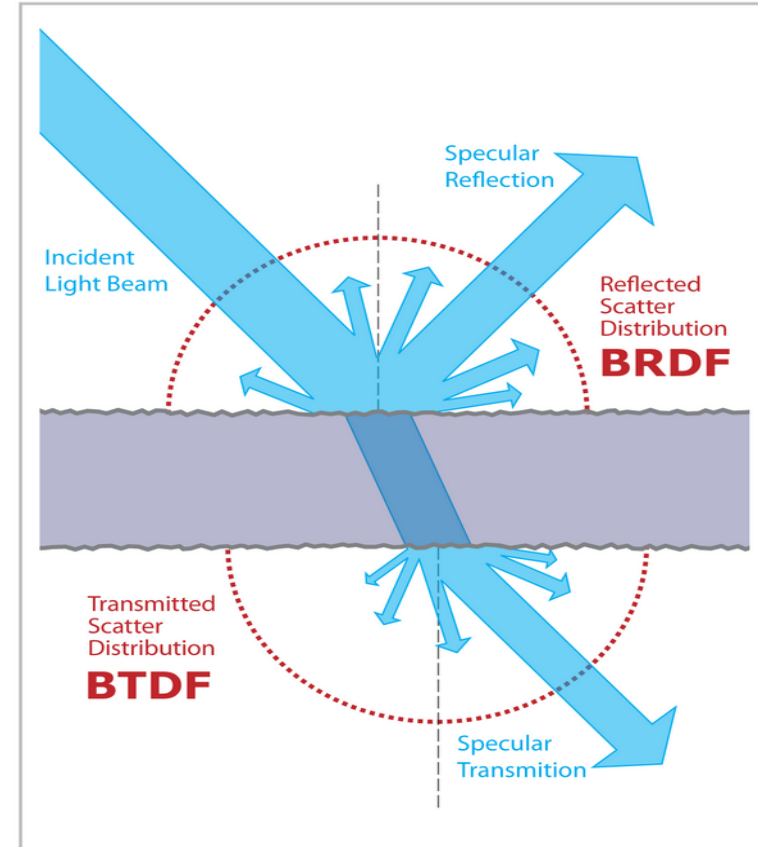



# SBRDF, BTF

- **SV-BRDF ... Spatially Varying BRDF**

- BRDF parameters are spatially varying (can be given by a surface texture)

- **BTF ... Bidirectional Texture Function**

- Used for materials with complex structure
- As opposed to the BRDF, models even the meso-scale



# BSSRDF

## ■ BRDF

- ❑ Light arriving at a point is reflected/transmitted at the same point
- ❑ No subsurface scattering considered

## ■ BSSRDF

- ❑ Bi-directional **surface scattering** reflectance distribution function
- ❑ Takes into account scattering of light under the surface

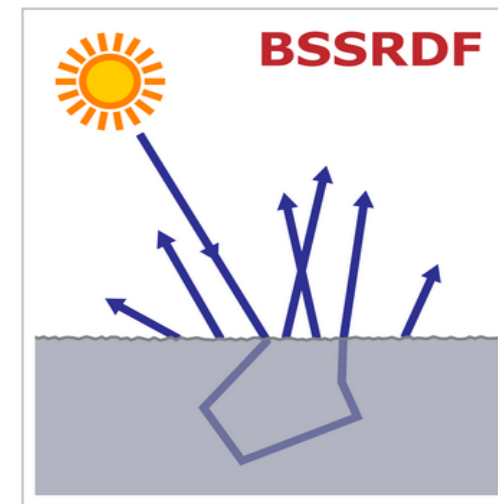
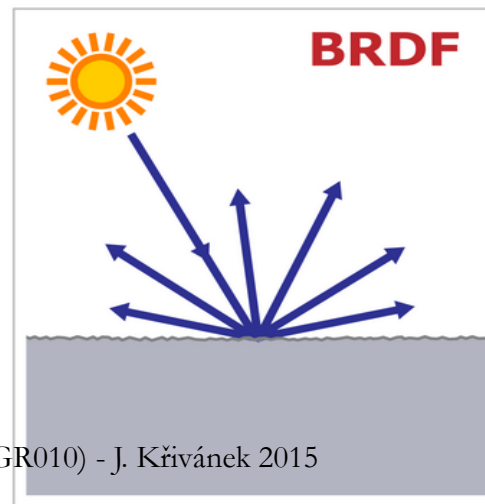

# BSSRDF

- Sub-surface scattering makes surfaces look “softer”



BRDF



BSSRDF

# BSSRDF



BRDF

BSSRDF